

scala - scale 1:2

sistema modulare per interni IP20 e per esterni IP67.

realizzato in alluminio estruso, ossidato e verniciato a polvere, disponibile nelle varianti configurate o da configurare a propria scelta.

modelli:

- c2 30x32 parete soffitto,*
- c1 30x48 parete soffitto sospensione,*
- c1 40x48 incasso,*
- ca 42x42 parete soffitto,*
- c 16.64 di sezione 90x50mm,*
- css 92x48 scomparsa totale,*
- csr 60x68 scomparsa totale radente,*
- c3 10x30.*

ogni profilo vuoto può essere tagliato alla lunghezza desiderata e si possono installare su di esso i seguenti kit di cablaggio elettrico: kit con sorgente elettronica lineare e diffusore in policarbonato satinato, kit con sorgente elettronica lineare e diffusore in policarbonato satinato h.5mm, kit con sorgente elettronica lineare e diffusore prismato, kit con sorgente elettronica lineare e lente ellittica in policarbonato, kit IP67 con sorgente elettronica lineare resinato, linea di luce con limitatore di corrente integrato, kit micromen 36,8x30x120mm cablato con sorgente elettronica 2700K e 3000K 2x1W fino a 2x90lm, kit vangogh 42x30x125mm cablato con sorgente elettronica 2700K e 3000K les6 2x2,2W fi no a 2x214lm, kit trentotto diametro Ø38mm 60x250mm cablato con sorgente elettronica 2700K e 3000K 5,6W 19° e 41° fi no a 544lm, kit eco mini diametro Ø55mm 69x250mm cablato con sorgente elettronica 2700K e 3000K fino a 12,4W 13° e 12,7W 19° 36° 24Vdc con dimmer incluso; kit trasparenze 100 di dimensioni 30x250mm e kit trasparenze 250 di dimensioni 30x300mm.

tutti i kit elettrici sono alimentati in tensione costante 24Vdc, alimentatore escluso.

accessori: tappi di chiusura laterale, coperchio cieco c system, giunti lineari, pulsante, raccordi, agganci orientabili per sistemi integrati, alimentatore 240V/24Vdc, kit di sospensione, supporti sorgenti elettroniche e linee di luce.

finiture: profili, profili IP67, kit micromen, kit vangogh, kit trentotto, kit eco mini e supporto trasparenze argento opaco, bianco V e nero55.

IP20 rated modular system for indoor use and IP67 rated for outdoor use.

made of powder and painted oxidised extruded aluminium, available in the configured version or to custom at user's discretion.

versions:

- c2 30x32 wall and ceiling version,**
- c1 30x48 wall, ceiling and suspension version,**
- c1 40x48 recessed,**
- ca 42x42 wall and ceiling version,**
- c 16.64 with a 90x50mm section;**
- css 92x48 fully concealed version;**
- csr 60x68 fully concealed grazing version;**
- c3 10x30.**

each hollow profile can be cutted to the desired length and is suitable to accommodate the following electrical wiring kits: kit with linear led source and frosted polycarbonate diffuser, kit with linear led source and h.5mm frosted polycarbonate diffuser, kit with linear led source and prismatic polycarbonate diffuser, kit with linear led source and polycarbonate elliptical lens, IP67 kit with resin linear led source, linea di luce with integrated current limiter, micromen spotlight kit 36.8x30x120mm wired with 2700K and 3000K 2x1W up to 2x90lm led source, vangogh spotlight kit 42x30x125mm wired with 2700K and 3000K les6 2x2,2W 2x214lm, trentotto spotlight kit diameter Ø38mm 60x250mm wired with 2700K and 3000K 5.6W 19° and 41° up to 544lm led source, eco mini spotlight kit with diameter Ø55mm 69x250mm wired with 2700K and 3000K up to 12.4W 13° and 12.7W 19° 31° 24Vdc led source with dimmer, trasparenze 100 kit 30x250mm and trasparenze 250 kit 30x300mm.

all the electrical kits are powered with 24Vdc constant voltage, power supply not included.

accessories: lateral end caps, c system blind lid, linear joints, push-button, various fittings, adjustable hooks for integrated systems, 240V/24Vdc power supply, suspension kit, led sources supports and linee di luce.

finishes: profiles, IP67 profiles, vangogh spotlight kit, trentotto kit, eco mini spotlight kit and trasparenze support matt silver, bianco V and nero55.



c system

kit lineare
diffusore satinato
frosted diffuser

kit lineare
diffusore satinato
frosted diffuser 5mm

kit lineare
diffusore prismato
prismatic diffuser

kit lineare
lente ellittica
elliptical lens

kit lineare
diffusore resinato IP67
resin diffuser

linea di luce

c2 30x32
mario nanni



c1 30x48
mario nanni

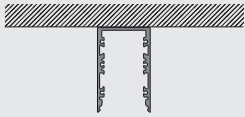

c1 40x48
mario nanni

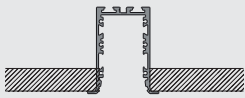

ca 42x42
mario nanni

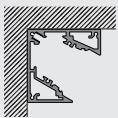

c 16.64
vittorio longheu

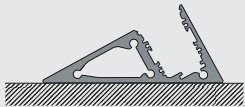

css 92x48
mario nanni

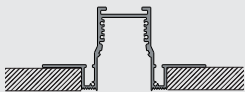

csr 60x68
mario nanni

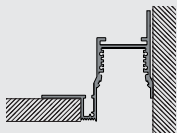

c3 10x30
mario nanni



kit micromen

kit vangogh

kit trentotto

kit eco mini

kit trasparenze

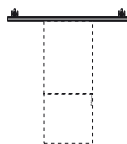
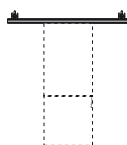
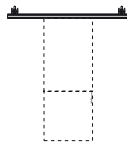
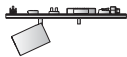
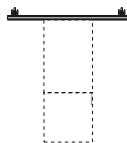
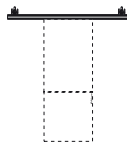
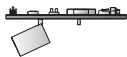

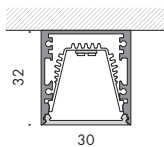
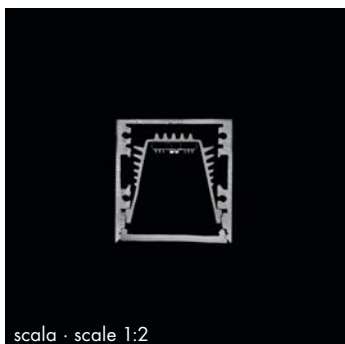

c2 30x32		24Vdc	IK	IP20	CE	☆	CE	i
Vb6.194.22	argento opaco · matt silver	3000K	14,7W	600mm	0,7			
Vb6.194.22.1	bianco V	3000K	14,7W	600mm	0,7			
Vb6.194.23	argento opaco · matt silver	3000K	22,5W	900mm	1			
Vb6.194.23.1	bianco V	3000K	22,5W	900mm	1			
Vb6.194.24	argento opaco · matt silver	3000K	30,3W	1200mm	1,3			
Vb6.194.24.1	bianco V	3000K	30,3W	1200mm	1,3			
Vb6.194.25	argento opaco · matt silver	3000K	38,1W	1500mm	1,6			
Vb6.194.25.1	bianco V	3000K	38,1W	1500mm	1,6			

Ra	R9	ies tm-30		sdc	V _f	lm/m	W/m	lm/W	█
95	90	Rf 93	Rg 102	step 2	24	2500	26	96	A+
V3001	¹¹ █	Ta25 °C		vita media · average life	50000 h	L80	B10		

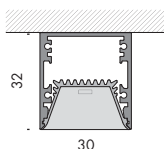

f6 30x32		24Vdc	IK10	IP67	CE	☆	CE	i
f6.194.41.1	argento opaco · matt silver	3000K	5W	513mm	0,8			
f6.194.42.1	argento opaco · matt silver	3000K	10W	1013mm	1,5			
f6.194.43.1	argento opaco · matt silver	3000K	20W	2013mm	3			
f6.194.44.1	argento opaco · matt silver	3000K	30W	3013mm	4,5			

Ra	ies tm/30		sdc	V _f	lm/m	W/m	lm/W	█
80	Rf 83	Rg 95	step 3	24	520	10	52	A
V1031	⁹ █	Ta25 °C		vita media · average life	50000 h	L80	B10	

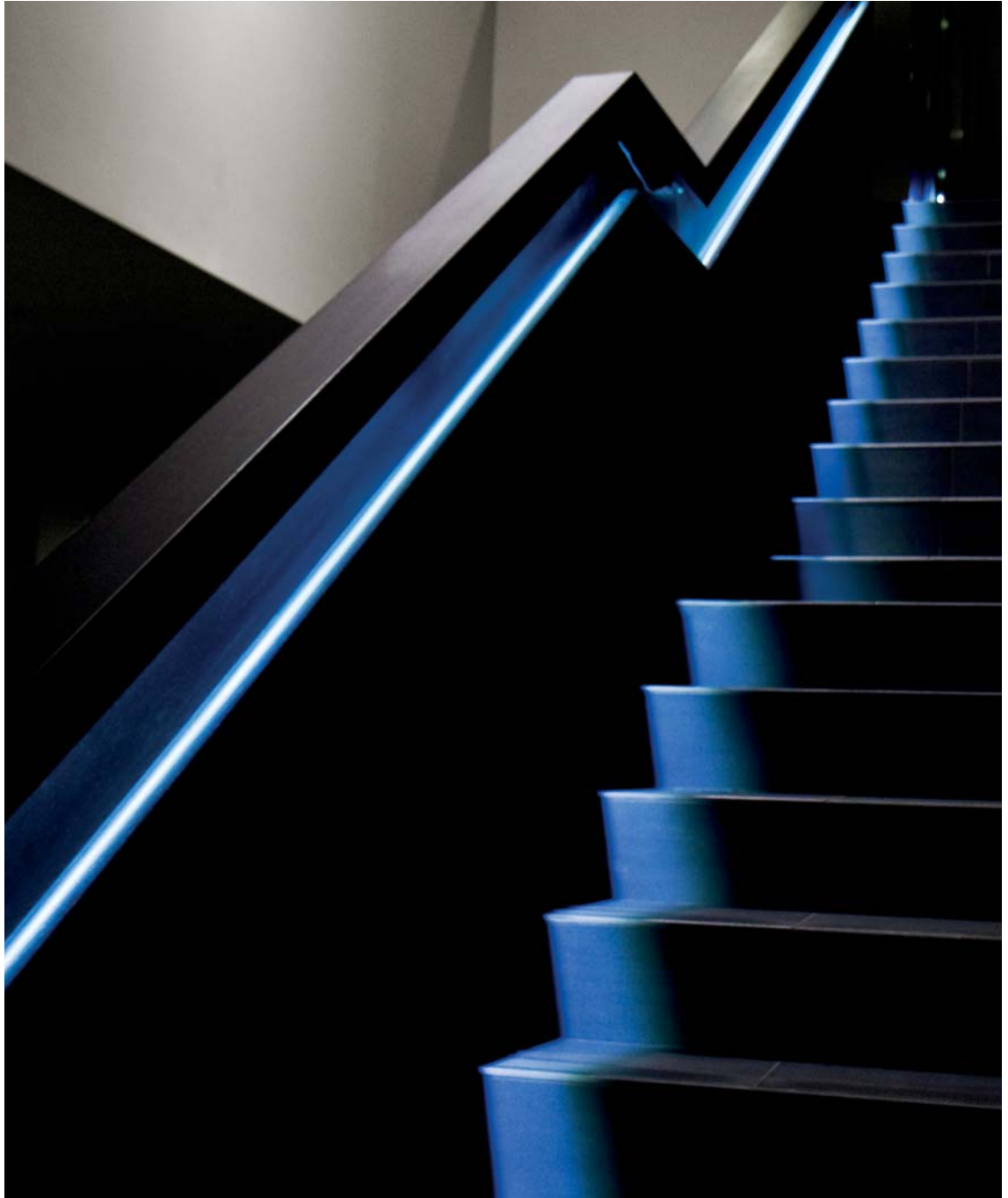

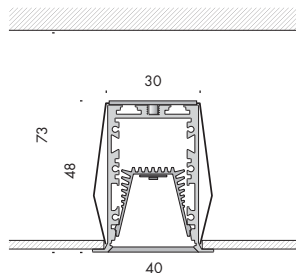

c1 40x48		24Vdc						
Vb6.193.22	argento opaco · matt silver	3000K	14,7W	600mm	0,7			
Vb6.193.22.1	bianco V	3000K	14,7W	600mm	0,7			
Vb6.193.23	argento opaco · matt silver	3000K	22,5W	900mm	1			
Vb6.193.23.1	bianco V	3000K	22,5W	900mm	1			
Vb6.193.24	argento opaco · matt silver	3000K	30,3W	1200mm	1,3			
Vb6.193.24.1	bianco V	3000K	30,3W	1200mm	1,3			
Vb6.193.25	argento opaco · matt silver	3000K	38,1W	1500mm	1,6			
Vb6.193.25.1	bianco V	3000K	38,1W	1500mm	1,6			

Ra	R9	ies tm-30		sdc	V _f	lm/m	W/m	lm/W	
95	90	Rf 93	Rg 102	step 2	24	2500	26	96	A+
V3001	¹¹	Ta25 °C		vita media · average life	50000 h	L80	B10		



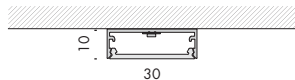
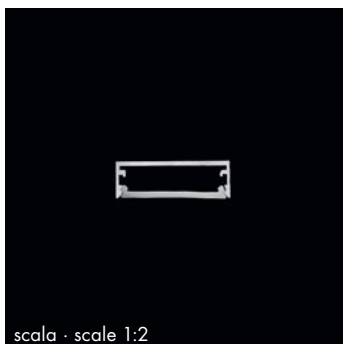

c3 10x30		24Vdc					
f6.209.06	argento opaco · matt silver	3000K	7,8W	620mm	0,7		
f6.209.06.1	bianco V	3000K	7,8W	620mm	0,7		
f6.209.09	argento opaco · matt silver	3000K	11,7W	920mm	1		
f6.209.09.1	bianco V	3000K	11,7W	920mm	1		
f6.209.12	argento opaco · matt silver	3000K	15,6W	1220mm	1,3		
f6.209.12.1	bianco V	3000K	15,6W	1220mm	1,3		
f6.209.15	argento opaco · matt silver	3000K	19,5W	1520mm	1,6		
f6.209.15.1	bianco V	3000K	19,5W	1520mm	1,6		

Ra	R9	ies tm/30		sdc	Vf	lm/m	W/m	lm/W	
95	90	Rf 93	Rg 102	step 2	24	1250	13	96	A+
V0001	5,9	Ta25 °C		vita media · average life	50000 h	L80	B10		





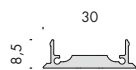
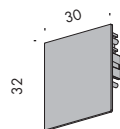
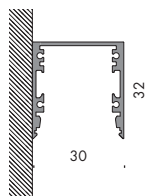
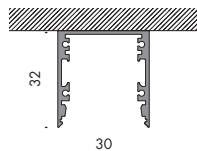
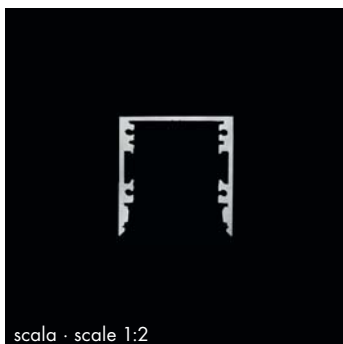

c2 30x32



Vb6.194.61	argento opaco · matt silver	3000mm	2,3
Vb6.194.62.1	bianco V	3000mm	2,3
Vb6.194.65	nero55	3000mm	2,3

c2 30x32 radente



Vb6.194.71	argento opaco · matt silver	3000mm	2,3
Vb6.194.72	bianco V	3000mm	2,3
Vb6.194.75	nero55	3000mm	2,3

tappi terminali. end caps.



f9.194.81	argento opaco · matt silver	2 pz · pcs	0,1
f9.194.82	bianco V	2 pz · pcs	0,1
f9.130.89	nero55	2 pz · pcs	0,1

coperchi. covers.



Vb9.194.03	argento opaco · matt silver	3000mm	2,3
Vb9.194.04	bianco V	3000mm	2,3
Vb9.194.05	nero55	3000mm	2,3



kit lineare
diffusore satinato
frosted diffuser



kit lineare
diffusore prismato
prismatic diffuser



kit lineare
lente ellittica
elliptic lens



kit lineare
diffusore resinato IP67
resin diffuser



linea di luce



kit micrometri



kit Vangogh

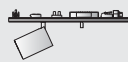

kit trentotto



kit eco mini



kit trasparenze

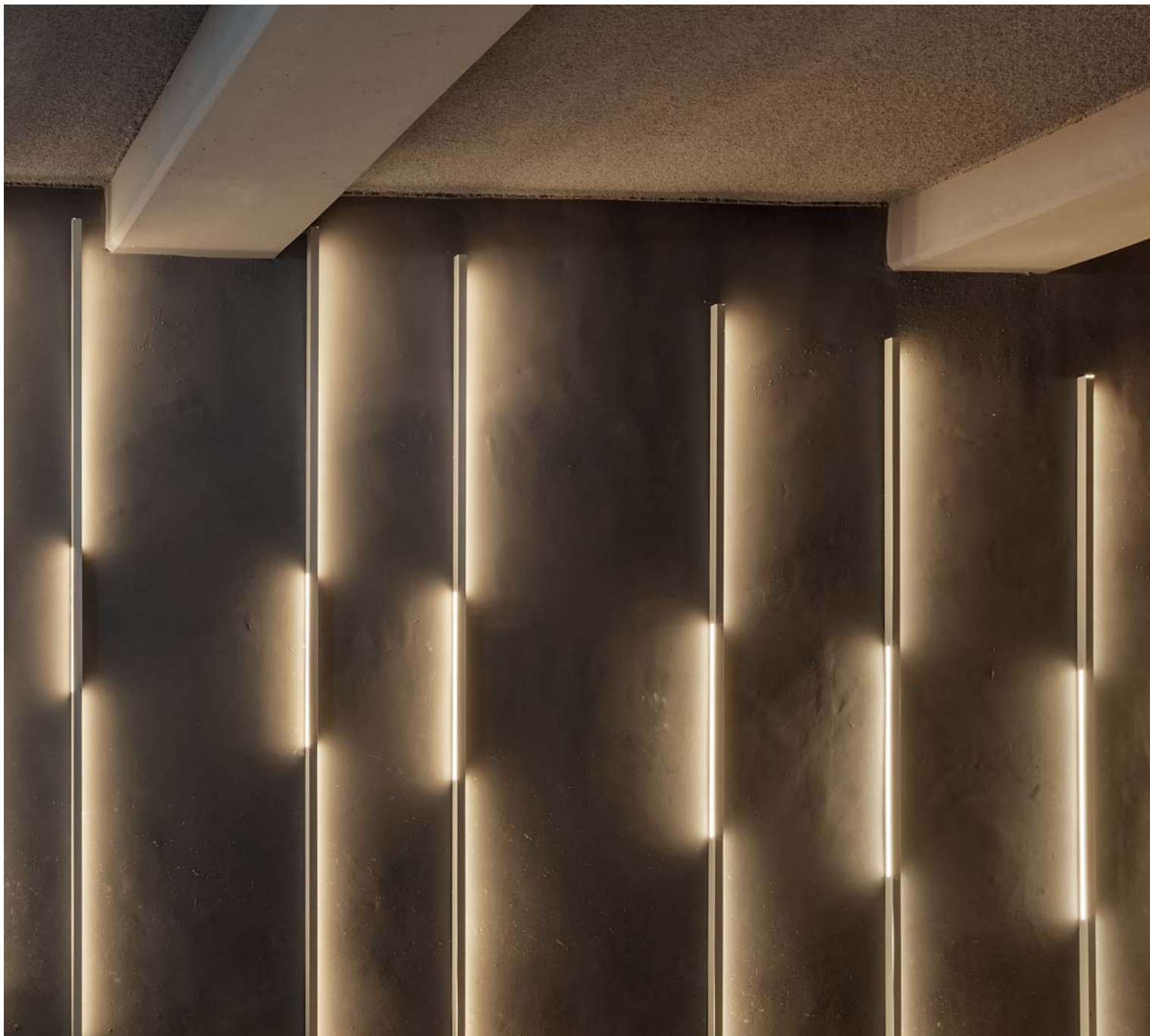

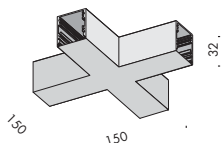
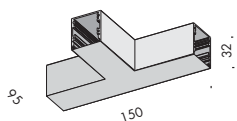
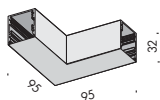
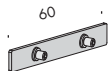
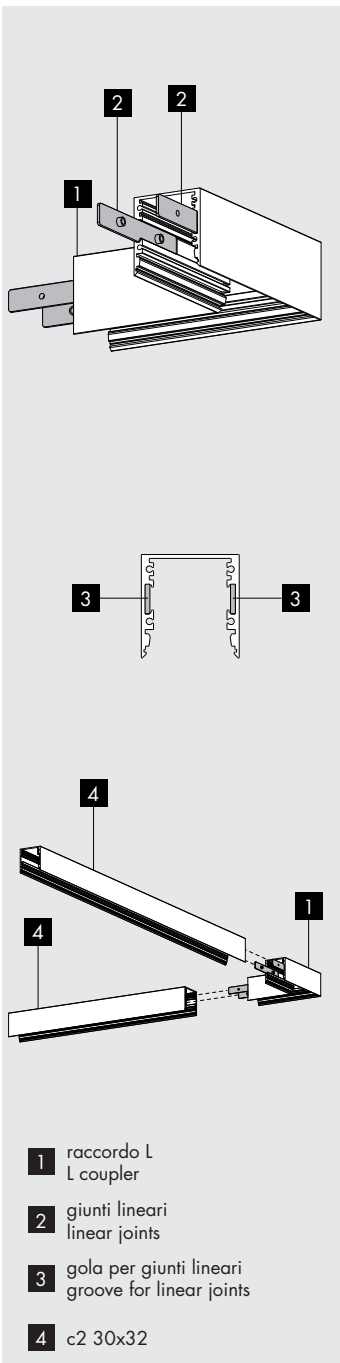

giunti. joints.

★ CE ⓘ

f9.131.01 lineari acciaio inox + grani
stainless steel linear + grub screws

2 pz · pcs 0,1

accessori. accessories.

★ CE ⓘ

f9.131.02 pulsante · switch

0,02

raccordi. couplers.

★ CE ⓘ

f9.130.82 raccordo L · L coupler argento opaco · matt silver 0,2

f9.130.92 raccordo L · L coupler bianco V 0,2

f9.130.86 raccordo L · L coupler nero55 0,2

f9.130.83 raccordo T · T coupler argento opaco · matt silver 0,2

f9.130.93 raccordo T · T coupler bianco V 0,2

f9.130.87 raccordo T · T coupler nero55 0,2

f9.130.84 raccordo + · + coupler argento opaco · matt silver 0,3

f9.130.94 raccordo + · + coupler bianco V 0,3

f9.130.88 raccordo + · + coupler nero55 0,3



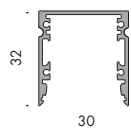
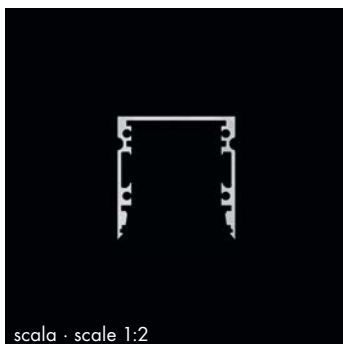

ck 30x32



Vb6.194.81	argento opaco · matt silver	3000mm	2,3
Vb6.194.82	bianco V	3000mm	2,3
Vb6.194.85	nero55	3000mm	2,3

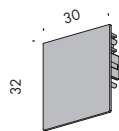

tappi terminali. end caps.



f9.194.81	argento opaco · matt silver	2 pz · pcs	0,1
f9.194.82	bianco V	2 pz · pcs	0,1
f9.130.89	nero55	2 pz · pcs	0,1



coperchi. covers.



Vb9.194.03	argento opaco · matt silver	3000mm	2,3
Vb9.194.04	bianco V	3000mm	2,3
Vb9.194.05	nero55	3000mm	2,3

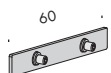

giunti. joints.



f9.131.01	lineari acciaio inox + grani stainless steel linear + grub screws	2 pz · pcs	0,1
------------------	--	------------	-----

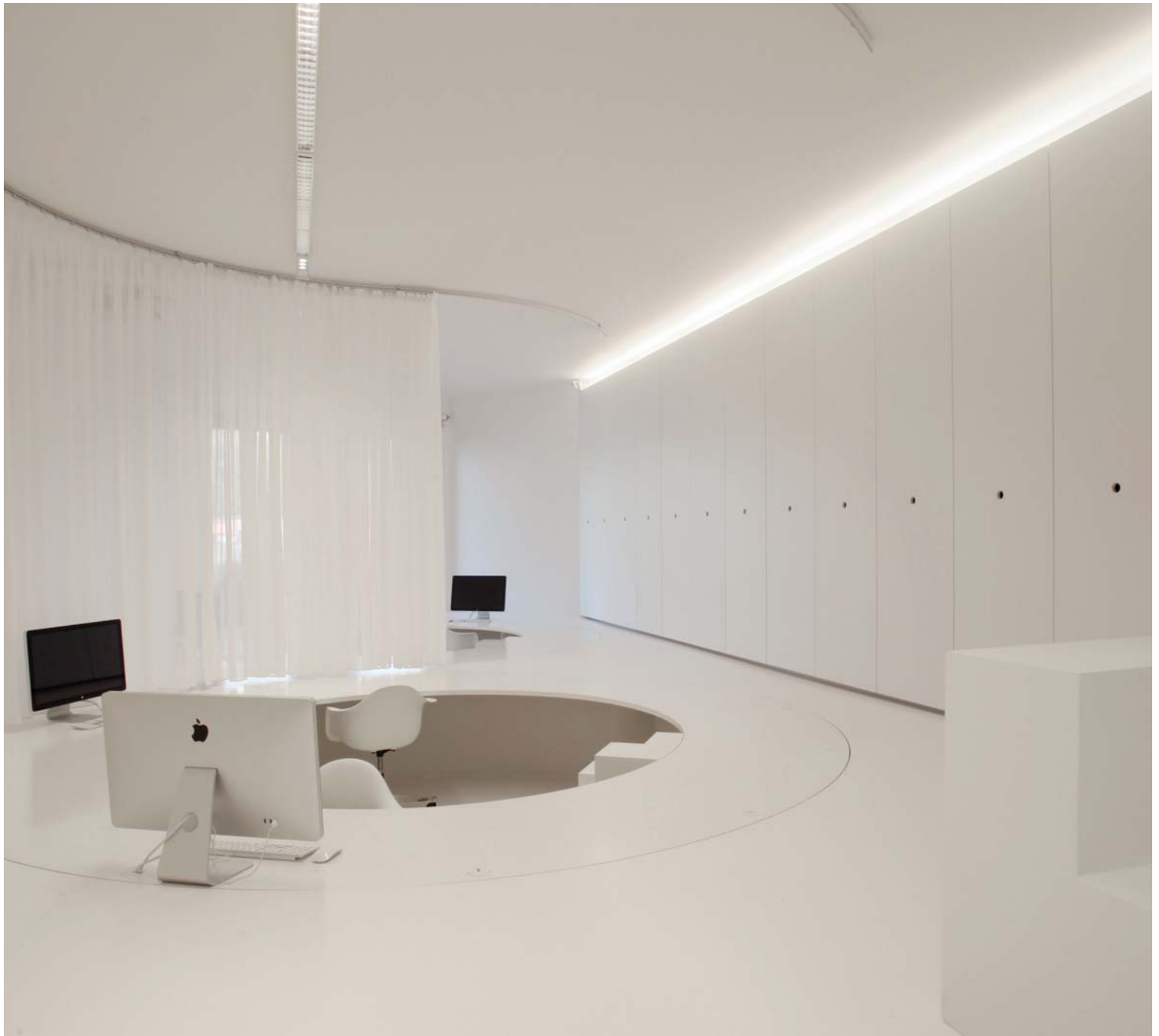

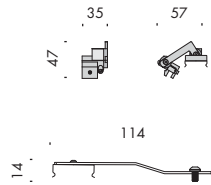

kit agganci 094/070. hooks kit.



Vb9.094.90 agganci orientabili · adjustable hooks 2 pz · pcs 0,1

Vb9.094.91 agganci fissi · fixed hooks 2 pz · pcs 0,1

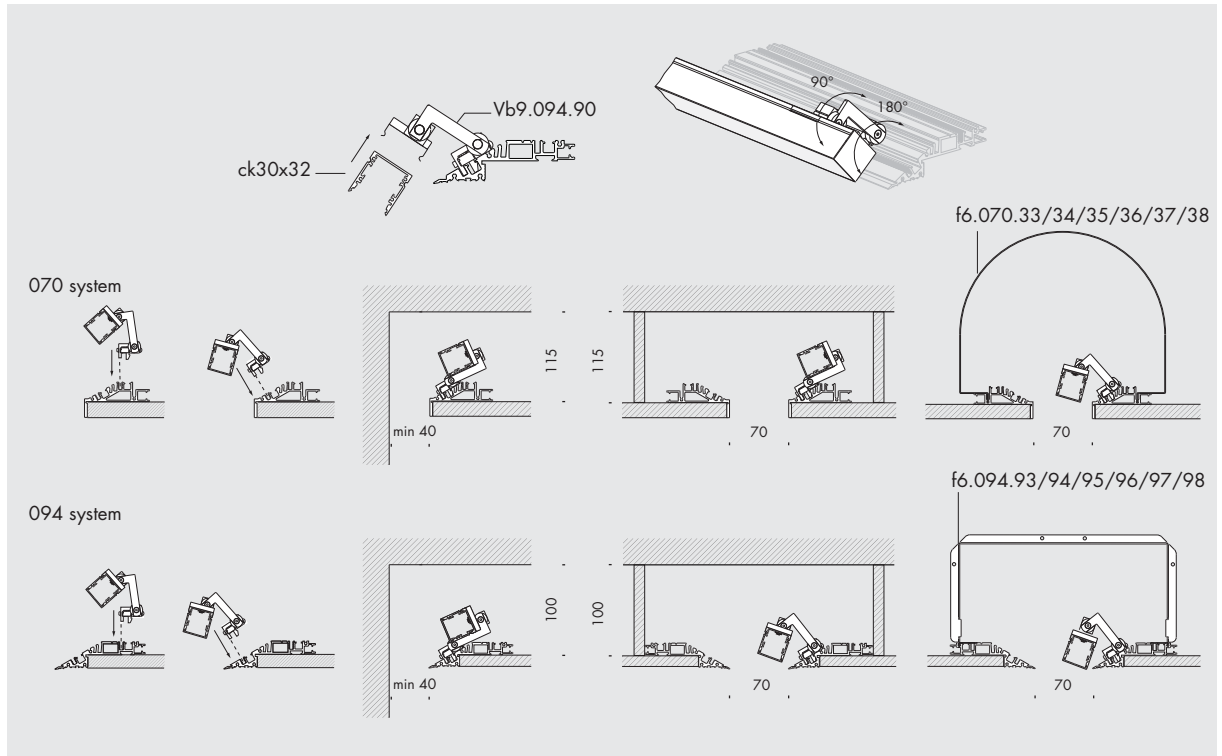
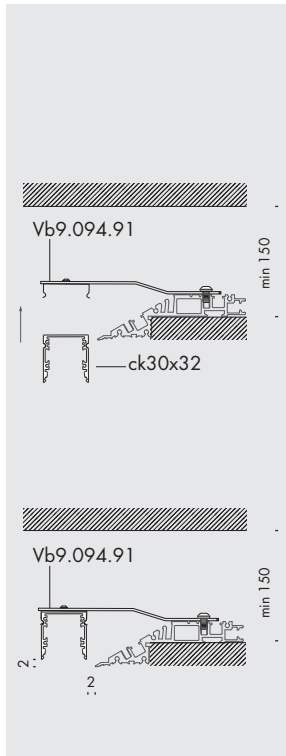



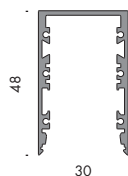
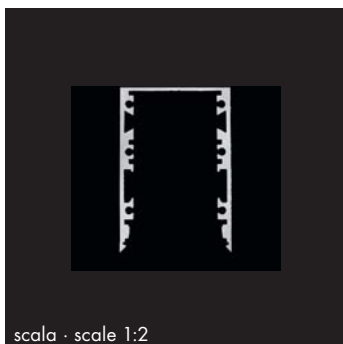

c1 30x48



Vb6.194.91	argento opaco · matt silver	3000mm	2,3
Vb6.194.92	bianco V	3000mm	2,3
Vb6.194.95	nero55	3000mm	2,3

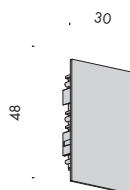

tappi terminali. end caps.



f9.521.81	argento opaco · matt silver	2 pz · pcs	0,1
f9.521.83	bianco V	2 pz · pcs	0,1
f9.521.82	nero55	2 pz · pcs	0,1



coperchi. covers.



Vb9.194.03	argento opaco · matt silver	3000mm	2,3
Vb9.194.04	bianco V	3000mm	2,3
Vb9.194.05	nero55	3000mm	2,3

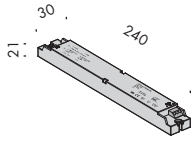

alimentatori. power supplies.		240V 50-60Hz	A	IP20	☆ CE	i
t4.215	24Vdc				60W	0,1

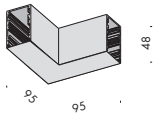

raccordi. couplers.		☆ CE	i
f9.521.01	raccordo L argento opaco · matt silver L coupler		0,2
f9.521.03	raccordo L bianco V · L coupler		0,2
f9.521.04	raccordo L nero55 · L coupler		0,2

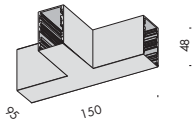

f9.521.06	raccordo T argento opaco · matt silver T coupler		0,2
f9.521.07	raccordo T bianco V · T coupler		0,2
f9.521.08	raccordo T nero55 · T coupler		0,2

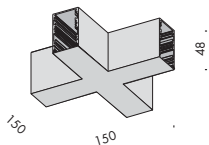

f9.521.11	raccordo + argento opaco · matt silver + coupler		0,3
f9.521.12	raccordo + bianco V · + coupler		0,3
f9.521.13	raccordo + nero55 · + coupler		0,3

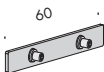

giunti. joints.

☆ CE ⓘ

f9.131.01 lineari acciaio inox + grani
stainless steel linear + grub screws

2 pz · pcs 0,1



accessori. accessories.

☆ CE ⓘ

f9.131.02 pulsante · switch

0,02



kit sospensione. suspension kit.

☆ CE ⓘ

Vb9.194.07 cavo sospensione
suspension cable

3000mm 1 pz · pcs 0,1



Vb9.194.08 cavo elettrico trasparente
transparent electric cable

3x0,75mm² 10000mm 0,5

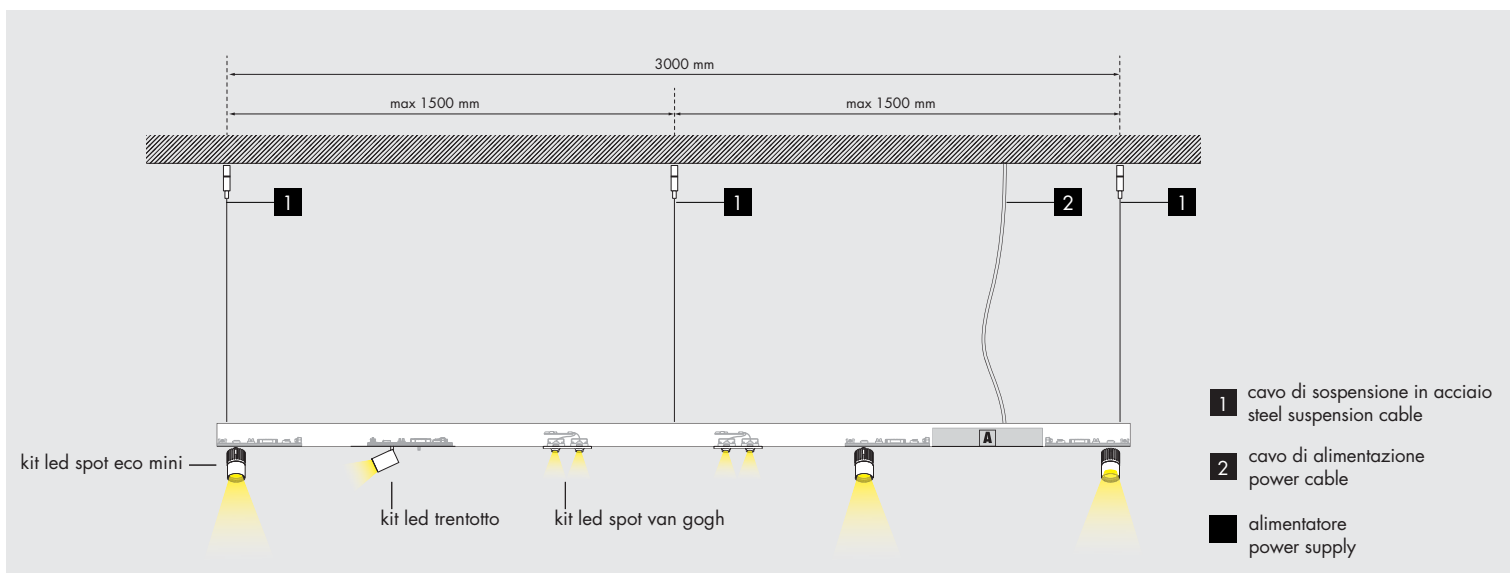



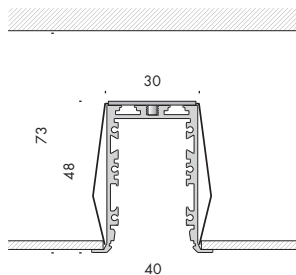
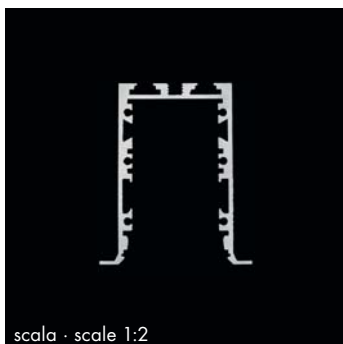

c1 40x48



Vb6.194.101	argento opaco · matt silver	3000mm	2,3
Vb6.194.102	bianco V	3000mm	2,3
Vb6.194.105	nero55	3000mm	2,3



kit lineare
diffusore satinato
frosted diffuser



kit lineare
diffusore prismato
prismatic diffuser



kit lineare
lente ellittica
elliptic lens



kit lineare
diffusore resinato IP67
resin diffuser



linea di luce



kit micromen



kit vangogh

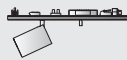

kit trentotto



kit eco mini



kit trasparenze

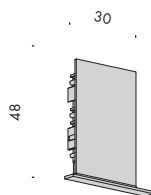

tappi terminali. end caps.



f9.129.81	argento opaco · matt silver	2 pz · pcs	0,1
f9.129.95	bianco V	2 pz · pcs	0,1
f9.129.97	nero55	2 pz · pcs	0,1

coperchi. covers.



Vb9.194.03	argento opaco · matt silver	3000mm	2,3
Vb9.194.04	bianco V	3000mm	2,3
Vb9.194.05	nero55	3000mm	2,3

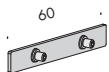

giunti. joints.		☆	CE	!
-----------------	--	---	----	---

f9.131.01	lineari acciaio inox + grani stainless steel linear + grub screws	2 pz · pcs	0,1
------------------	--	------------	-----



accessori. accessories.		☆	CE	!
-------------------------	--	---	----	---

f9.131.02	pulsante · switch		0,02
------------------	-------------------	--	------



f9.129.96	molle per incasso · recess springs	2 pz · pcs	0,6
------------------	------------------------------------	------------	-----

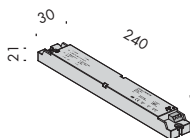

alimentatori. power supplies.		240V 50-60Hz	A	IP20	CE	!
-------------------------------	--	--------------	---	------	----	---

t4.215	24Vdc	60W	0,1
---------------	-------	-----	-----

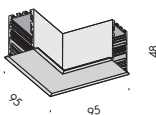

raccordi. couplers.		☆	CE	!
---------------------	--	---	----	---

f9.129.82	raccordo L argento opaco · matt silver L coupler		0,2
------------------	--	--	-----

f9.129.92	raccordo L bianco V · L coupler		0,2
------------------	---------------------------------	--	-----

f9.129.102	raccordo L nero55 · L coupler		0,2
-------------------	-------------------------------	--	-----

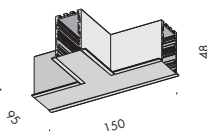

f9.129.83	raccordo T argento opaco · matt silver T coupler		0,2
------------------	--	--	-----

f9.129.93	raccordo T bianco V · T coupler		0,2
------------------	---------------------------------	--	-----

f9.129.103	raccordo T nero55 · T coupler		0,2
-------------------	-------------------------------	--	-----

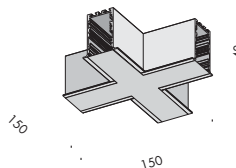

f9.129.84	raccordo + argento opaco · matt silver + coupler		0,3
------------------	--	--	-----

f9.129.94	raccordo + bianco V · + coupler		0,3
------------------	---------------------------------	--	-----

f9.129.104	raccordo + nero55 · + coupler		0,3
-------------------	-------------------------------	--	-----

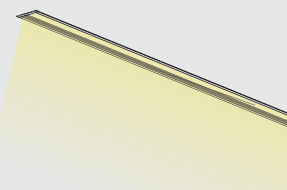
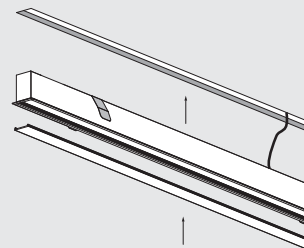
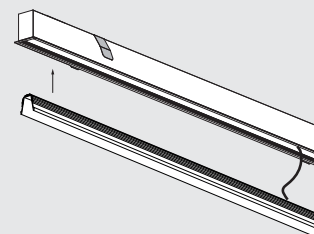
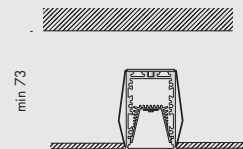

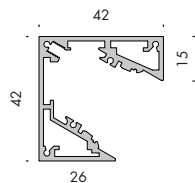
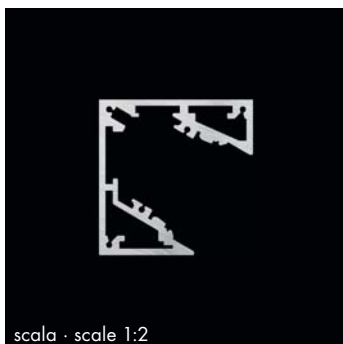

ca 42x42



Vb6.194.111	argento opaco · matt silver	3000mm	2,3
Vb6.194.112	bianco V	3000mm	2,3
Vb6.194.115	nero55	3000mm	2,3



kit lineare
diffusore satinato
frosted diffuser



kit lineare
diffusore prismato
prismatic diffuser



kit lineare
lente ellittica
elliptic lens



kit lineare
diffusore resinato IP67
resin diffuser

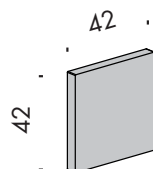

linea di luce



kit micromen



kit vangogh

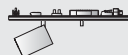

kit trentotto



kit eco mini



tappi terminali. end caps.

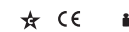

Vb9.194.11	argento opaco · matt silver	2 pz · pcs	0,1
Vb9.194.12	bianco V	2 pz · pcs	0,1
Vb9.194.15	nero55	2 pz · pcs	0,1

coperchi. covers.



Vb9.194.03	argento opaco · matt silver	3000mm	2,3
Vb9.194.04	bianco V	3000mm	2,3
Vb9.194.05	nero55	3000mm	2,3

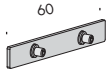

giunti. joints.



f9.131.01 lineari acciaio inox + grani
stainless steel linear + grub screws

2 pz · pcs 0,1



accessori. accessories.



f9.131.02 pulsante · switch

0,02

ca 42x42

valori lux ricavati considerando le seguenti distanze:

lux values obtained by considering the following distances:

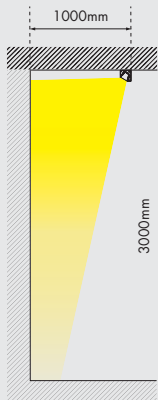

- a 380 lux
- b 320 lux
- c 280 lux
- d 240 lux
- e 200 lux
- f 160 lux
- g 120 lux

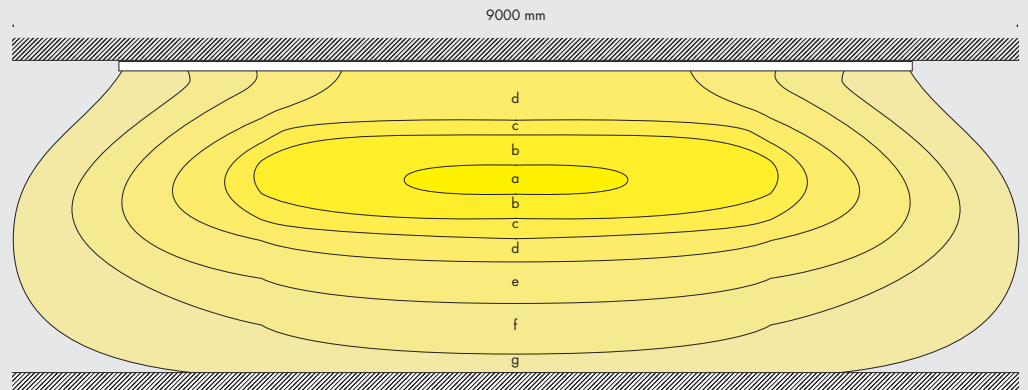

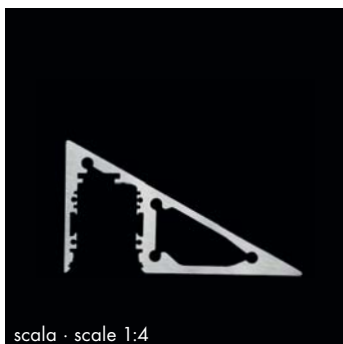

scala · scale 1:4

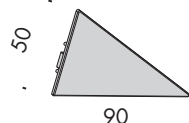
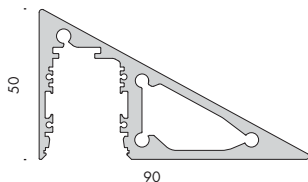

c 16.64



Vb6.194.121	argento opaco · matt silver	3000mm	2,3
Vb6.194.122	bianco V	3000mm	2,3
Vb6.194.125	nero55	3000mm	2,3

tappi terminali. end caps.



f9.090.94	argento opaco · matt silver	2 pz · pcs	0,1
f9.090.91	bianco V	2 pz · pcs	0,1
f9.090.95	nero55	2 pz · pcs	0,1

coperchi. covers.



Vb9.194.03	argento opaco · matt silver	3000mm	2,3
Vb9.194.04	bianco V	3000mm	2,3
Vb9.194.05	nero55	3000mm	2,3

giunti. joints.



f9.090.93	lineari acciaio inox + grani stainless steel linear + grub screws	2 pz · pcs	0,2
------------------	--	------------	-----



kit lineare
diffusore satinato
frosted diffuser



kit lineare
diffusore prismato
prismatic diffuser



kit lineare
lente ellittica
elliptic lens



kit lineare
diffusore resinato IP67
resin diffuser



linea di luce



kit micromen



kit vangogh



kit trentotto



kit eco mini

installazione a parete
wall mounting

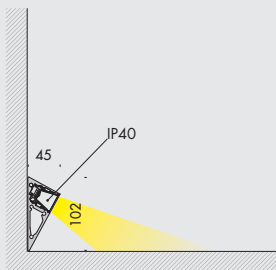

installazione ad incasso
recessed installation

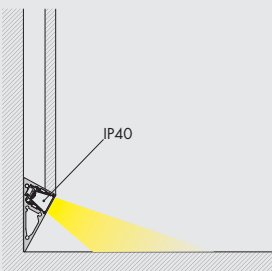

installazione ad incasso
con possibilità di ripresa aria
condizionata
recessed installation with the
possibility of air conditioning intake

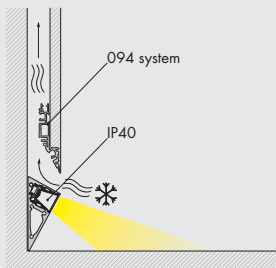

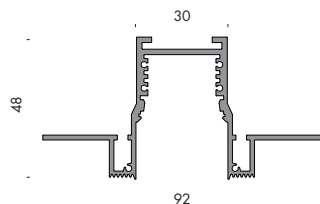
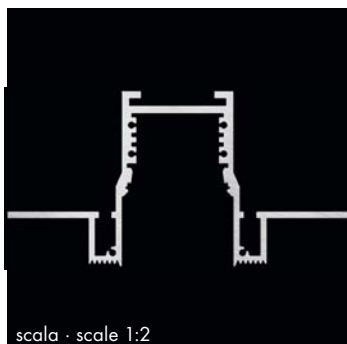

css 92x48



Vb6.194.131	argento opaco · matt silver	3000mm	2,3
Vb6.194.132	bianco V	3000mm	2,3
Vb6.194.135	nero55	3000mm	2,3

tappi terminali. end caps.



Vb9.194.21	argento opaco · matt silver	2 pz · pcs	0,1
Vb9.194.22	bianco V	2 pz · pcs	0,1
Vb9.194.27	nero55	2 pz · pcs	0,1

giunti. joints.



Vb9.194.25	lineari acciaio inox + grani stainless steel linear + grub screws	2 pz · pcs	0,1
Vb9.194.29	angolari acciaio inox + grani stainless steel angle + grub screws	2 pz · pcs	0,1

coperchi. covers.



Vb9.194.03	argento opaco · matt silver	3000mm	2,3
Vb9.194.04	bianco V	3000mm	2,3
Vb9.194.05	nero55	3000mm	2,3

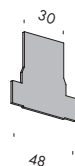
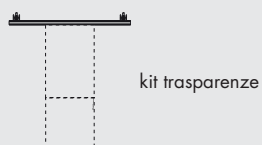
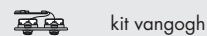
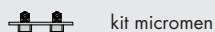
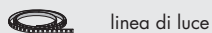
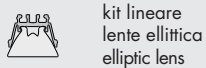
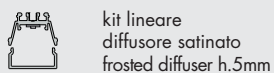

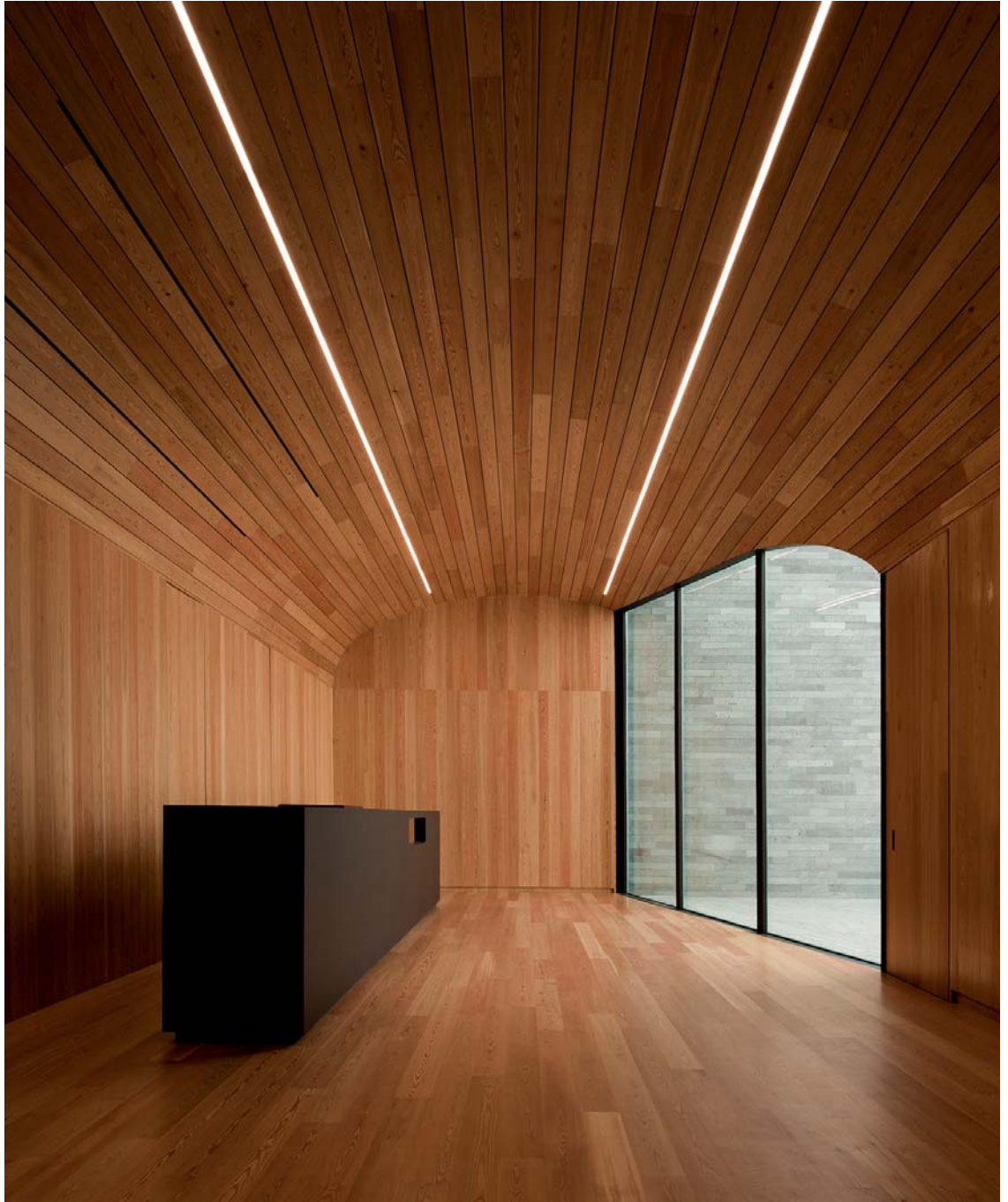
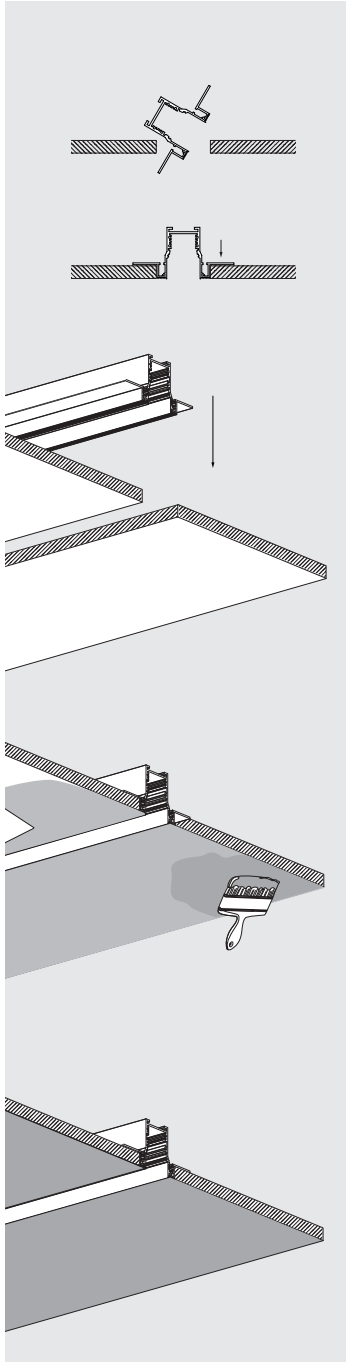

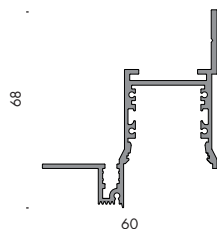
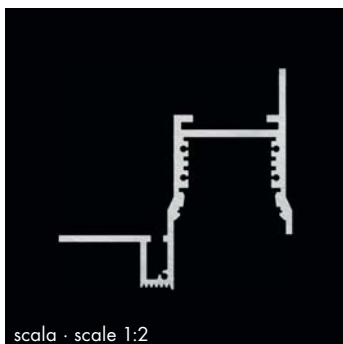

linea di luce



kit lineare
diffusore satinato
frosted diffuser h.5mm



kit lineare
lente ellittica
elliptic lens



kit micromen



kit vangogh



kit trasparenze



csr 60x68



Vb6.194.141	argento opaco · matt silver	3000mm	2,3
Vb6.194.142	bianco V	3000mm	2,3
Vb6.194.145	nero55	3000mm	2,3

tappi terminali. end caps.



Vb9.194.31	argento opaco · matt silver	2 pz · pcs	0,1
Vb9.194.32	bianco V	2 pz · pcs	0,1
Vb9.194.35	nero55	2 pz · pcs	0,1

giunti. joints.



Vb9.194.25	lineari acciaio inox + grani stainless steel linear + grub screws	2 pz · pcs	0,1
Vb9.194.29	angolari acciaio inox + grani stainless steel angle + grub screws	2 pz · pcs	0,1

coperchi. covers.



Vb9.194.03	argento opaco · matt silver	3000mm	2,3
Vb9.194.04	bianco V	3000mm	2,3
Vb9.194.05	nero55	3000mm	2,3

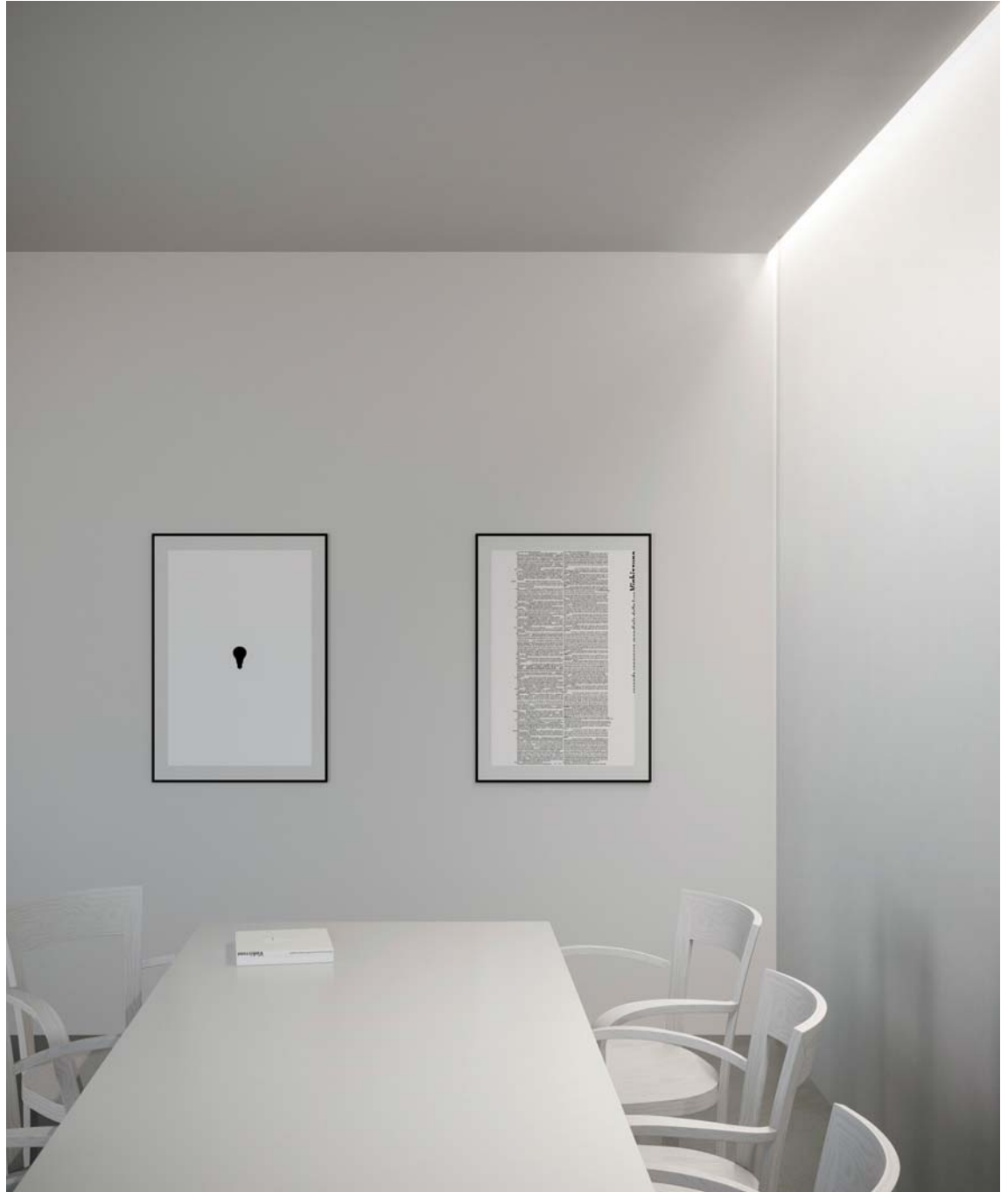
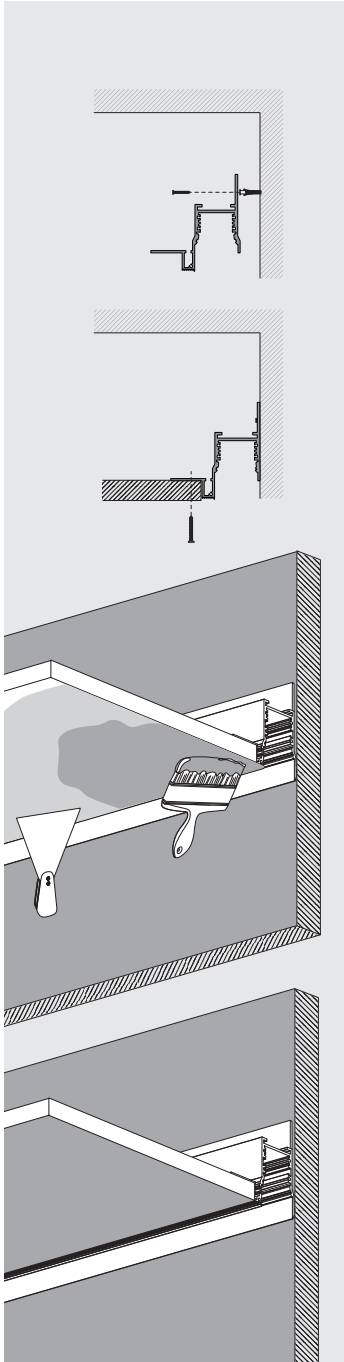

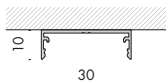
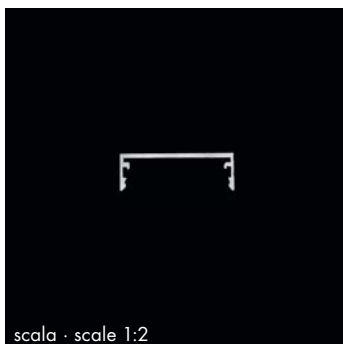

c3 10x30



Vb6.194.151	argento opaco · matt silver	3000mm	2,3
Vb6.194.152	bianco V	3000mm	2,3
Vb6.194.155	nero55	3000mm	2,3



linea di luce

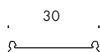

diffusori. diffusers.



Vb9.194.41	polycarbonato satinato frosted polycarboate	3000mm	0,1
Vb9.194.42	polycarbonato prismato prismatic polycarboate	3000mm	0,1



tappi terminali. end caps.



f9.209.98	argento opaco · matt silver	2 pz · pcs	0,1
f9.209.99	bianco V	2 pz · pcs	0,1
f9.209.100	nero55	2 pz · pcs	0,1

**giunti. joints.**

★ CE ⓘ

f9.209.90 lineari acciaio inox + grani
stainless steel linear + grub screws

2 pz · pcs 0,1

**coperchi. covers.**

★ CE ⓘ

Vb9.194.03 argento opaco · matt silver

3000mm 2,3

Vb9.194.04 bianco V

3000mm 2,3

Vb9.194.05 nero55

3000mm 2,3



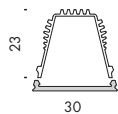
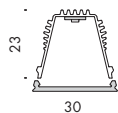
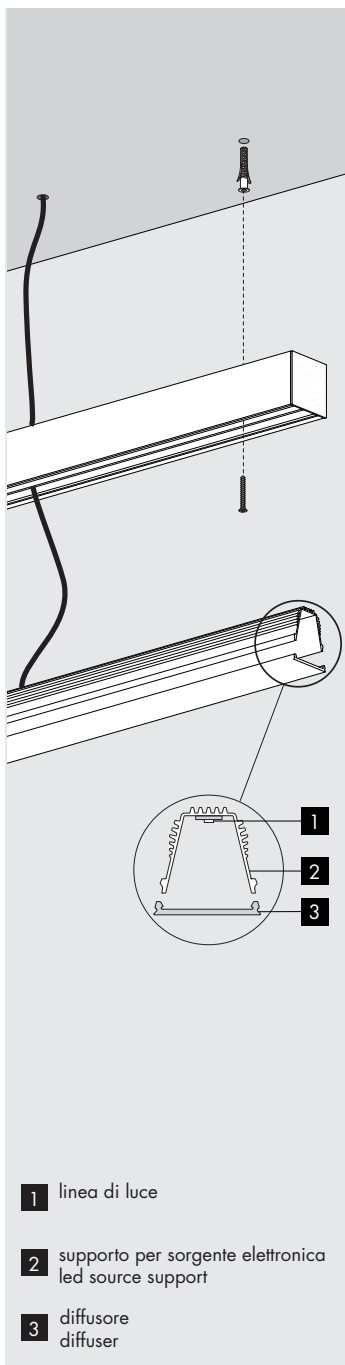

1 linea di luce

2 supporto per sorgente elettronica
led source support

3 diffusore
diffuser

kit lineare satinato frosted 24Vdc

Vb9.194.152.27	2700K	15,6W	610mm	0,5
Vb9.194.153.27	2700K	23,4W	910mm	0,7
Vb9.194.154.27	2700K	31,2W	1210mm	1
Vb9.194.155.27	2700K	39W	1510mm	1,2
Vb9.194.156.27	2700K	78W	3010mm	2,3

Ra	R9	ies tm-30		sdc	V _f	lm/m	W/m	lm/W	
95	90	Rf 90	Rg 98	step 2	24	2400	26	92	A+
V3000	¹¹	Ta25 °C		vita media · average life	50000 h	L80	B10		

Vb9.194.152.30	3000K	15,6W	610mm	0,5
Vb9.194.153.30	3000K	23,4W	910mm	0,7
Vb9.194.154.30	3000K	31,2W	1210mm	1
Vb9.194.155.30	3000K	39W	1510mm	1,2
Vb9.194.156.30	3000K	78W	3010mm	2,3

Ra	R9	ies tm-30		sdc	V _f	lm/m	W/m	lm/W	
95	90	Rf 93	Rg 102	step 2	24	2500	26	96	A+
V3001	¹¹	Ta25 °C		vita media · average life	50000 h	L80	B10		

supporto per sorgente elettronica. led source support.

Vb9.194.150	alluminio ossidato argento con diffusore satinato silver oxidate aluminium with frosted diffuser	3000mm	0,6
--------------------	---	--------	-----

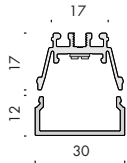

kit lineare satinato frosted 5mm 24Vdc

Vb9.194.172.27	kit led css 92x48/csr 60x68	2700K	15,6W	610mm	0,5
Vb9.194.173.27	kit led css 92x48/csr 60x68	2700K	23,4W	910mm	0,7
Vb9.194.174.27	kit led css 92x48/csr 60x68	2700K	31,2W	1210mm	1
Vb9.194.175.27	kit led css 92x48/csr 60x68	2700K	39W	1510mm	1,2
Vb9.194.176.27	kit led css 92x48/csr 60x68	2700K	78W	3010mm	2,3

Ra	R9	ies tm-30		sdcn	V _f	lm/m	W/m	lm/W	
95	90	Rf 90	Rg 98	step 2	24	2400	26	92	A+
V3000	11	Ta25 °C		vita media · average life	50000 h	L80	B10		

Vb9.194.172.30	kit led css 92x48/csr 60x68	3000K	15,6W	610mm	0,5
Vb9.194.173.30	kit led css 92x48/csr 60x68	3000K	23,4W	910mm	0,7
Vb9.194.174.30	kit led css 92x48/csr 60x68	3000K	31,2W	1210mm	1
Vb9.194.175.30	kit led css 92x48/csr 60x68	3000K	39W	1510mm	1,2
Vb9.194.176.30	kit led css 92x48/csr 60x68	3000K	78W	3010mm	2,3

Ra	R9	ies tm-30		sdcn	V _f	lm/m	W/m	lm/W	
95	90	Rf 93	Rg 102	step 2	24	2500	26	96	A+
V3001	11	Ta25 °C		vita media · average life	50000 h	L80	B10		

supporto per sorgente elettronica. led source support.

Vb9.194.170	alluminio ossidato argento con diffusore satinato 5mm silver oxidate aluminium with 5mm frosted diffuser	3000mm	0,6
--------------------	---	--------	-----

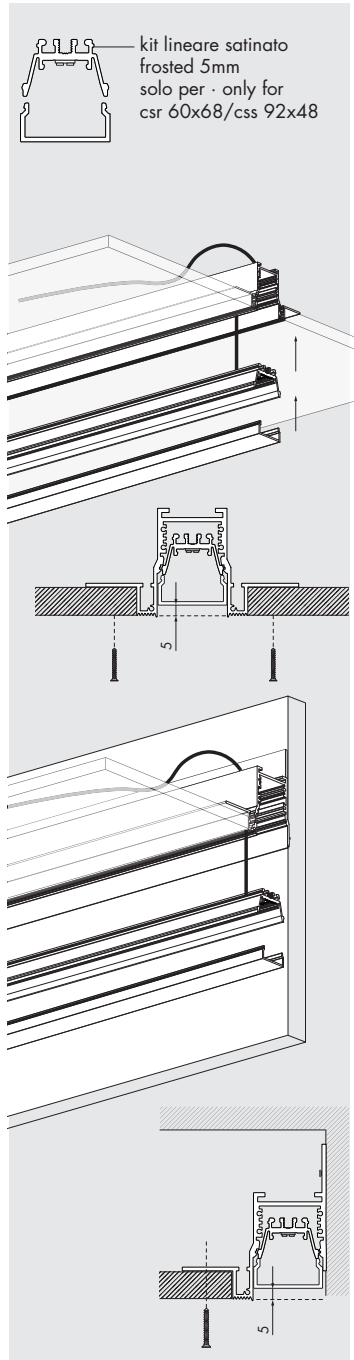
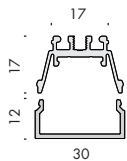

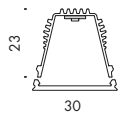

kit lineare prismato prismatic		24Vdc					CE	
Vb9.194.162.27	2700K	15,6W	610mm	0,5				
Vb9.194.163.27	2700K	23,4W	910mm	0,7				
Vb9.194.164.27	2700K	31,2W	1210mm	1				
Vb9.194.165.27	2700K	39W	1510mm	1,2				
Vb9.194.166.27	2700K	78W	3010mm	2,3				

Ra	R9	ies tm-30		sdc	V _f	lm/m	W/m	lm/W	
95	90	Rf 90	Rg 98	step 2	24	2400	26	92	A+
V3000			Ta25 °C	vita media · average life	50000 h	L80	B10		

Vb9.194.162.30	3000K	15,6W	610mm	0,5				
Vb9.194.163.30	3000K	23,4W	910mm	0,7				
Vb9.194.164.30	3000K	31,2W	1210mm	1				
Vb9.194.165.30	3000K	39W	1510mm	1,2				
Vb9.194.166.30	3000K	78W	3010mm	2,3				

Ra	R9	ies tm-30		sdc	V _f	lm/m	W/m	lm/W	
95	90	Rf 93	Rg 102	step 2	24	2500	26	96	A+
V3001			Ta25 °C	vita media · average life	50000 h	L80	B10		

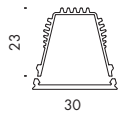

supporto per sorgente elettronica. led source support.				CE	
Vb9.194.160	alluminio ossidato argento con diffusore prismato silver oxidate aluminium with prismatic diffuser	3000mm			0,6



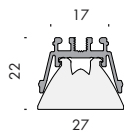
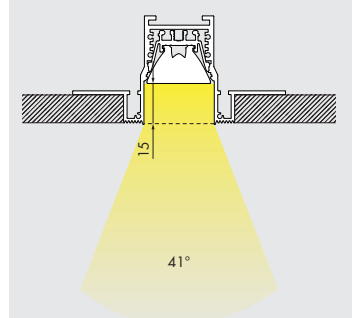
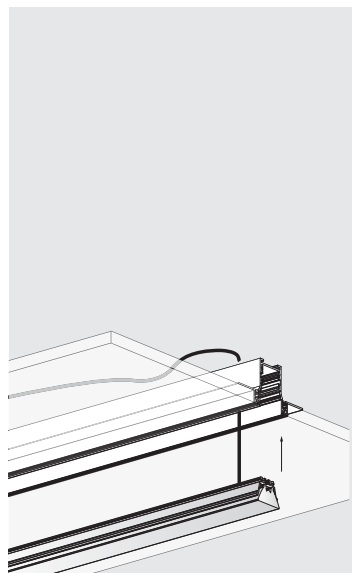
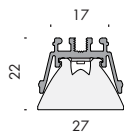

kit lineare ellittica elliptical		24Vdc	Ⓜ	Ⓚ	Ⓢ	IP20	⚠	★	CE	Ⓜ
Vb9.194.182.27	2700K	7,8W	41°x84°	610mm	0,5					
Vb9.194.183.27	2700K	11,7W	41°x84°	910mm	0,7					
Vb9.194.184.27	2700K	15,6W	41°x84°	1210mm	1					
Vb9.194.185.27	2700K	19,5W	41°x84°	1510mm	1,2					
Vb9.194.186.27	2700K	39W	41°x84°	3010mm	2,3					

Ra	R9	ies tm/30		sdc	Vf	lm/m	W/m	lm/W	Ⓜ
95	90	Rf 90	Rg 98	step 2	24	1200	13	92	A+
V0000	5,9	Ta25 °C		vita media · average life	50000 h	L80	B10		

Vb9.194.182.30	3000K	7,8W	41°x84°	610mm	0,5					
Vb9.194.183.30	3000K	11,7W	41°x84°	910mm	0,7					
Vb9.194.184.30	3000K	15,6W	41°x84°	1210mm	1					
Vb9.194.185.30	3000K	19,5W	41°x84°	1510mm	1,2					
Vb9.194.186.30	3000K	39W	41°x84°	3010mm	2,3					

Ra	R9	ies tm/30		sdc	Vf	lm/m	W/m	lm/W	Ⓜ
95	90	Rf 93	Rg 102	step 2	24	1250	13	96	A+
V0001	5,9	Ta25 °C		vita media · average life	50000 h	L80	B10		

supporto per sorgente elettronica. led source support.		★	Ⓚ	CE	Ⓜ
Vb9.194.180	alluminio ossidato argento con lente ellittica silver oxidate aluminium with elliptical lens	41°x84°	3000mm	0,6	



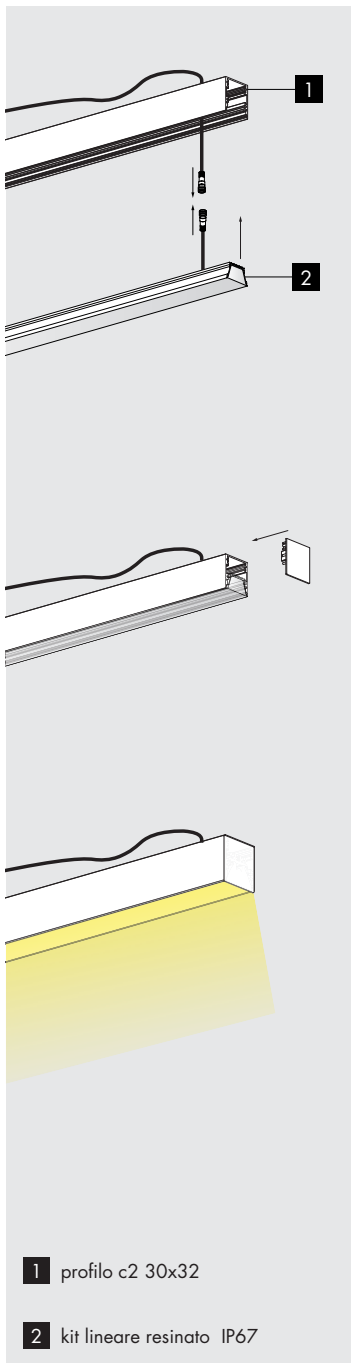

1 profilo c2 30x32

2 kit lineare resinato IP67

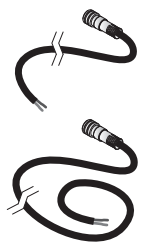
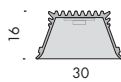

kit lineare resinato resin IP67 24Vdc

Vb6.250.01	3000K con connettori m/f	6W	610mm	0,5
Vb6.250.02	3000K con connettori m/f	9W	910mm	0,9
Vb6.250.03	3000K con connettori m/f	12W	1210mm	1,1
Vb6.250.04	3000K con connettori m/f	15W	1510mm	1,3
Vb6.250.05	3000K con connettori m/f	30W	3010mm	2,7

Ra	ies lm/30		sdc	Vf	lm/m	W/m	lm/W	
80	Rf 83	Rg 95	step 3	24	520	10	52	A
V1031	9 Ta25 °C		vita media · average life	50000 h	L80	B10		

cavi con connettore femmina m8. cables with m8 female connector. IP67

f9.250.71	150mm	0,01
f9.164.86	2000mm	0,1
f9.164.87	5000mm	0,2
f9.164.88	10000mm	0,3

cavi con connettori m/f m8. cables with m/f m8 connectors. IP67

f9.250.72	2000mm	0,1
f9.250.73	5000mm	0,3
f9.250.74	10000mm	0,6



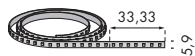
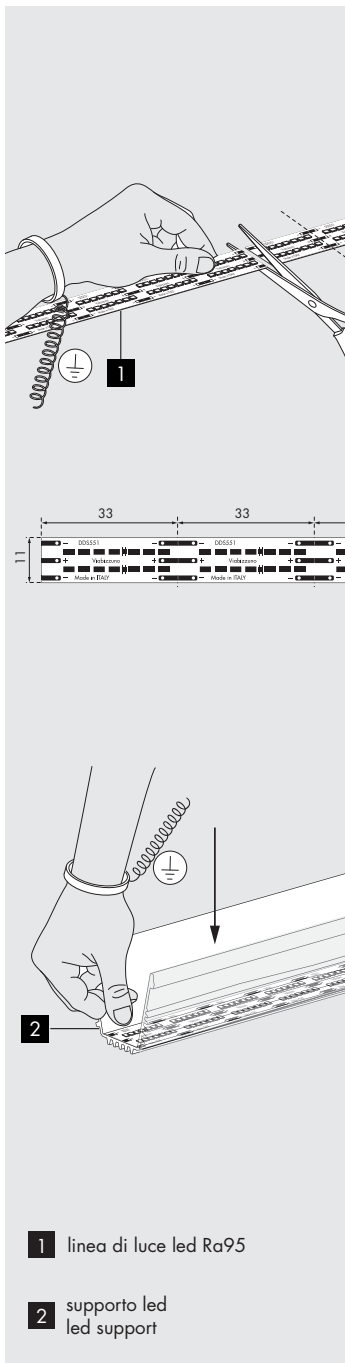

1 linea di luce led Ra95

2 supporto led
led support

linea di luce Ra95/13

24Vdc



Vb6.250.121

2700K 6000mm 0,6

Ra	R9	ies tm/30		sdc	Vf	lm/m	W/m	lm/W	
95	90	Rf 90	Rg 98	step 2	24	1200	13	92	A+
V0000	5,9	Ta25 °C		vita media · average life		50000 h	L80 B10		

Vb6.250.122

3000K 6000mm 0,6

Ra	R9	ies tm/30		sdc	Vf	lm/m	W/m	lm/W	
95	90	Rf 93	Rg 102	step 2	24	1250	13	96	A+
V0001	5,9	Ta25 °C		vita media · average life		50000 h	L80 B10		

Vb6.250.123

4000K 6000mm 0,6

Ra	R9	ies tm/30		sdc	Vf	lm/m	W/m	lm/W	
95	95	Rf 90	Rg 98	step 2	24	1300	13	100	A+
V0003	5,9	Ta25 °C		vita media · average life		50000 h	L80 B10		

Vb6.250.124

5000K 6000mm 0,6

Ra	R9	ies tm/30		sdc	Vf	lm/m	W/m	lm/W	
95	95	Rf 90	Rg 98	step 2	24	1300	13	100	A+
V0005	5,9	Ta25 °C		vita media · average life		50000 h	L80 B10		



linea di luce Ra95/26 **24Vdc**

Vb6.250.155 2700K 6000mm 0,6

Ra	R9	ies tm-30		sdcn	V _f	lm/m	W/m	lm/W	
95	90	Rf 90	Rg 98	step 2	24	2400	26	92	A+
V3000	11	Ta25 °C		vita media · average life		50000 h	L80	B10	

Vb6.250.156 3000K 6000mm 0,6

Ra	R9	ies tm-30		sdcn	V _f	lm/m	W/m	lm/W	
95	90	Rf 93	Rg 102	step 2	24	2500	26	96	A+
V3001	11	Ta25 °C		vita media · average life		50000 h	L80	B10	

Vb6.250.157 4000K 6000mm 0,6

Ra	R9	ies tm/30		sdcn	V _f	lm/m	W/m	lm/W	
95	95	Rf 90	Rg 98	step 2	24	2600	26	100	A+
V3003	11	Ta25 °C		vita media · average life		50000 h	L80	B10	

Vb6.250.158 5000K 6000mm 0,6

Ra	R9	ies tm/30		sdcn	V _f	lm/m	W/m	lm/W	
95	95	Rf 90	Rg 98	step 2	24	2600	26	100	A+
V3005	11	Ta25 °C		vita media · average life		50000 h	L80	B10	

Vb6.250.130 2700/4000K 6000mm 0,6

Ra	R9	ies tm/30		sdcn	V _f	lm/m	W/m	lm/W	
95	90	Rf 90	Rg 98	step 2	24	1200	13	92	A+
V0000	11	Ta25 °C		vita media · average life		50000 h	L80	B10	

Ra	R9	ies tm/30		sdcn	V _f	lm/m	W/m	lm/W	
95	95	Rf 90	Rg 98	step 2	24	1300	13	100	A+
V0003	11	Ta25 °C		vita media · average life		50000 h	L80	B10	

linea di luce **3x24Vdc pwm**



f6.250.25.1 rgb 14W/m 300lm/m 6000mm 0,6

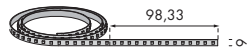





linea di luce Ra80/6 **24Vdc**    **CE** 



f6.250.31 2700K 6000mm 0,6

Ra	ies tm/30		sdc	Vf	lm/m	W/m	lm/W	
80	Rf 82	Rg 91	step 2	24	580	6	97	A+
V1000	9  Ta25 °C		vita media · average life		50000 h	L80 B10		



f6.250.32 3000K 6000mm 0,6

Ra	ies tm/30		sdc	Vf	lm/m	W/m	lm/W	
80	Rf 83	Rg 94	step 2	24	600	6	100	A++
V1001	9  Ta25 °C		vita media · average life		50000 h	L80 B10		

f6.250.33 4000K 6000mm 0,6

Ra	ies tm/30		sdc	Vf	lm/m	W/m	lm/W	
80	Rf 81	Rg 92	step 2	24	624	6	104	A++
V1003	9  Ta25 °C		vita media · average life		50000 h	L80 B10		

f6.250.34 5000K 6000mm 0,6

Ra	ies tm/30		sdc	Vf	lm/m	W/m	lm/W	
80	Rf 80	Rg 90	step 2	24	624	6	104	A++
V1005	9  Ta25 °C		vita media · average life		50000 h	L80 B10		



linea di luce Ra80/12 **24Vdc**

f6.250.41 2700K 6000mm 0,6

Ra	ies tm/30		sdcn	Vf	lm/m	W/m	lm/W	
80	Rf 82	Rg 91	step 2	24	1160	12	97	A+
V1010	° Ta25 °C		vita media · average life		50000 h	L80	B10	

f6.250.42 3000K 6000mm 0,6

Ra	ies tm/30		sdcn	Vf	lm/m	W/m	lm/W	
80	Rf 83	Rg 94	step 2	24	1200	12	100	A+
V1011	° Ta25 °C		vita media · average life		50000 h	L80	B10	

f6.250.43 4000K 6000mm 0,6

Ra	ies tm/30		sdcn	Vf	lm/m	W/m	lm/W	
80	Rf 81	Rg 92	step 2	24	1248	12	104	A+
V1013	° Ta25 °C		vita media · average life		50000 h	L80	B10	



f6.250.44 5000K 6000mm 0,6

Ra	ies tm/30		sdcn	Vf	lm/m	W/m	lm/W	
80	Rf 80	Rg 90	step 2	24	1248	12	104	A+
V1015	° Ta25 °C		vita media · average life		50000 h	L80	B10	





linea di luce Ra80/20 **24Vdc**     **CE** 



f6.250.51 2700K 6000mm 0,6

Ra	ies tm/30		sdc	Vf	lm/m	W/m	lm/W	
80	Rf 82	Rg 91	step 2	24	1933	20	97	A+
V1020	°  Ta25 °C		vita media · average life		50000 h	L80 B10		



f6.250.52 3000K 6000mm 0,6

Ra	ies tm/30		sdc	Vf	lm/m	W/m	lm/W	
80	Rf 83	Rg 94	step 2	24	2000	20	100	A+
V1021	°  Ta25 °C		vita media · average life		50000 h	L80 B10		

f6.250.53 4000K 6000mm 0,6

Ra	ies tm/30		sdc	Vf	lm/m	W/m	lm/W	
80	Rf 81	Rg 92	step 2	24	2080	20	104	A+
V1023	°  Ta25 °C		vita media · average life		50000 h	L80 B10		

f6.250.54 5000K 6000mm 0,6

Ra	ies tm/30		sdc	Vf	lm/m	W/m	lm/W	
80	Rf 80	Rg 90	step 2	24	2080	20	104	A+
V1025	°  Ta25 °C		vita media · average life		50000 h	L80 B10		

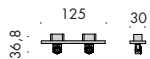

kit micromen 13° 24Vdc

Vb9.194.195.27 argento opaco · matt silver 2700K 2x1W 13°-13° 0,1

Vb9.194.196.27 bianco V 2700K 2x1W 13°-13° 0,1

Vb9.194.197.27 nero55 2700K 2x1W 13°-13° 0,1

Ra	ies tm-30		sdc	mA	V _{f (min)}	lm	W	lm/W	
90	Rf 90	Rg 100	step 2	300	2,8	170	2,0	85	A++
ca010-2	les2	• Ta25 °C	vita media · average life		50000 h	L80	B10		

Vb9.194.194.30 argento opaco · matt silver 3000K 2x1W 13°-13° 0,1

Vb9.194.195.30 bianco V 3000K 2x1W 13°-13° 0,1

Vb9.194.196.30 nero55 3000K 2x1W 13°-13° 0,1

Ra	ies tm-30		sdc	mA	V _{f (min)}	lm	W	lm/W	
90	Rf 90	Rg 100	step 2	300	2,8	180	2,0	90	A++
ca011-2	les2	• Ta25 °C	vita media · average life		50000 h	L80	B10		

kit micromen 25° 24Vdc

Vb9.194.198.27 argento opaco · matt silver 2700K 2x1W 25°-25° 0,1

Vb9.194.199.27 bianco V 2700K 2x1W 25°-25° 0,1

Vb9.194.200.27 nero55 2700K 2x1W 25°-25° 0,1

Ra	ies tm-30		sdc	mA	V _{f (min)}	lm	W	lm/W	
90	Rf 90	Rg 100	step 2	300	2,8	170	2,0	85	A++
ca010-2	les2	• Ta25 °C	vita media · average life		50000 h	L80	B10		

Vb9.194.198.30 argento opaco · matt silver 3000K 2x1W 25°-25° 0,1

Vb9.194.199.30 bianco V 3000K 2x1W 25°-25° 0,1

Vb9.194.200.30 nero55 3000K 2x1W 25°-25° 0,1

Ra	ies tm-30		sdc	mA	V _{f (min)}	lm	W	lm/W	
90	Rf 90	Rg 100	step 2	300	2,8	180	2,0	90	A++
ca011-2	les2	• Ta25 °C	vita media · average life		50000 h	L80	B10		

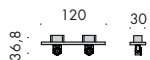

kit micromen 13°

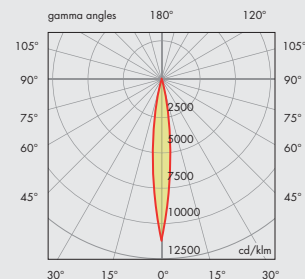

kit micromen 25°

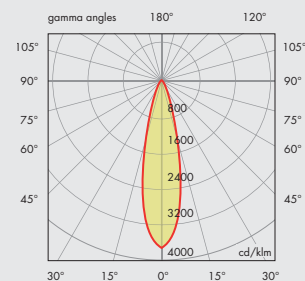

kit vangogh 21°

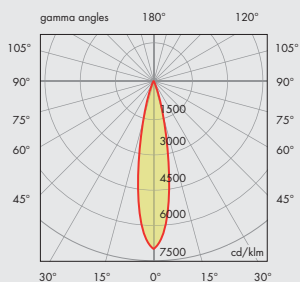

kit vangogh 24Vdc IP20

Vb9.194.191.27 argento opaco · matt silver 2700K 2x2,2W 21°-21° 0,1

Vb9.194.192.27 bianco V 2700K 2x2,2W 21°-21° 0,1

Vb9.194.193.27 nero55 2700K 2x2,2W 21°-21° 0,1

Ra	ies tm-30		sdc	mA	V _{f (min)}	lm	W	lm/W	
95	Rf 92	Rg 100	step 2	250	17,6	376	4,4	86	A++
cd020-2	les6	Ta25 °C		vita media · average life		50000 h	L80 B10		

Vb9.194.191.30 argento opaco · matt silver 3000K 2x2,2W 21°-21° 0,1

Vb9.194.192.30 bianco V 3000K 2x2,2W 21°-21° 0,1

Vb9.194.193.30 nero55 3000K 2x2,2W 21°-21° 0,1

Ra	ies tm-30		sdc	mA	V _{f (min)}	lm	W	lm/W	
95	Rf 92	Rg 100	step 2	250	17,6	428	4,4	97	A++
cd021-2	les6	Ta25 °C		vita media · average life		50000 h	L80 B10		

kit trentotto 19°

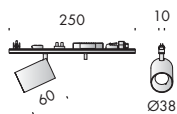
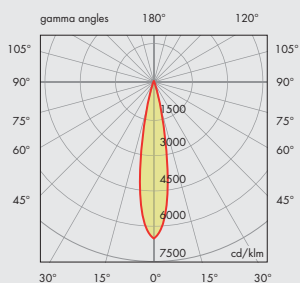

kit trentotto 19° 24Vdc IP20

Vb9.194.227.27 argento opaco · matt silver 2700K 19° 0,2

Vb9.194.228.27 bianco V 2700K 19° 0,2

Vb9.194.226.27 nero55 2700K 19° 0,2

Ra	R9	ies tm-30		sdc	mA	V _{f (min)}	lm	W	lm/W	
95	95	Rf 95	Rg 100	step 2	350	16,0	544	5,6	97	A+
cd040	les6	Ta25 °C		vita media · average life		50000 h	L70 B10			

Vb9.194.227.30 argento opaco · matt silver 3000K 19° 0,2

Vb9.194.228.30 bianco V 3000K 19° 0,2

Vb9.194.226.30 nero55 3000K 19° 0,2

Ra	ies tm-30		sdc	mA	V _{f (min)}	lm	W	lm/W	
95	Rf 92	Rg 100	step 2	350	17	455	6	76	A+
cd011	les6	Ta25 °C		vita media · average life		50000 h	L70 B10		

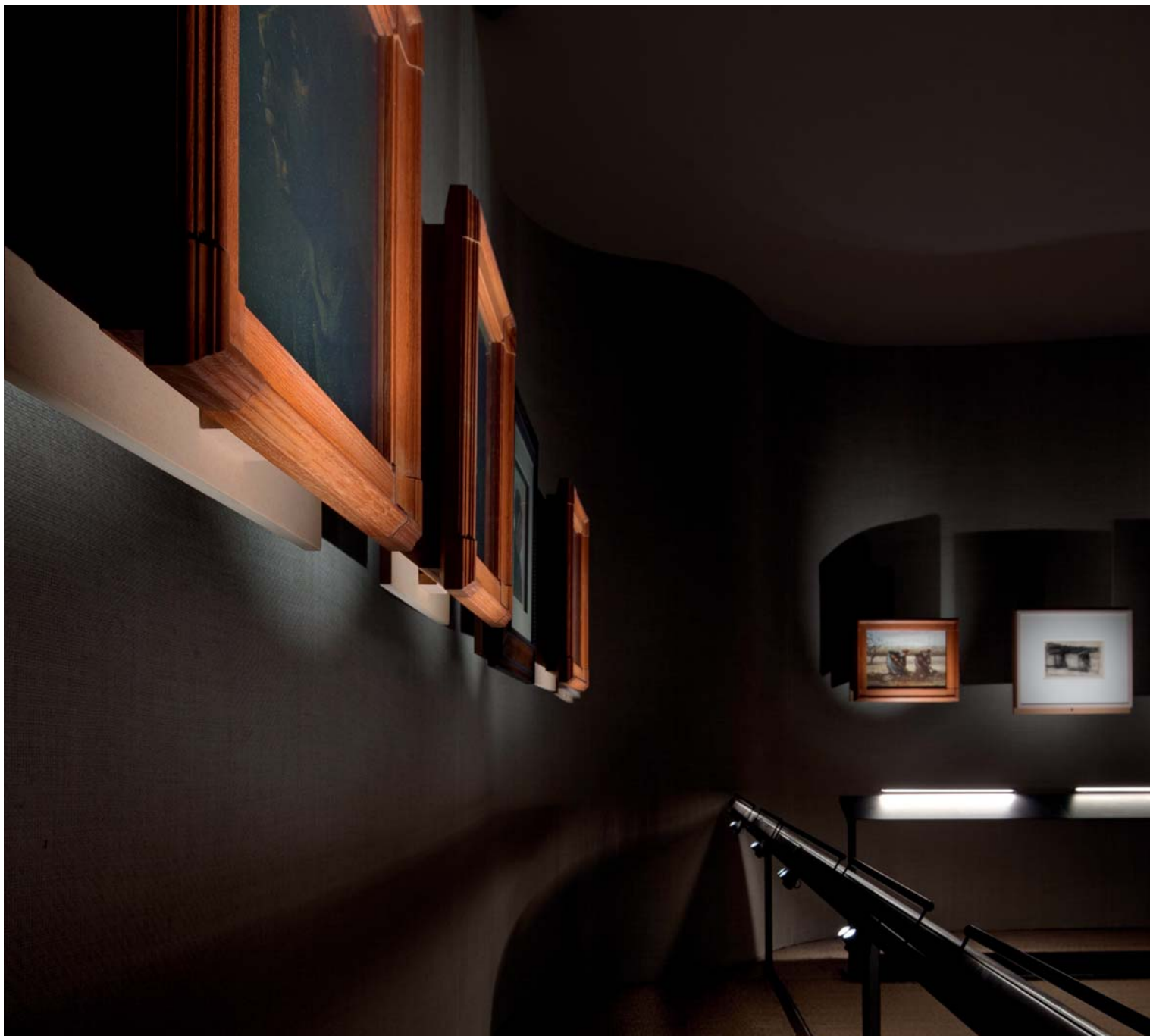

kit trentotto 41°

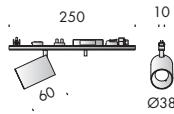
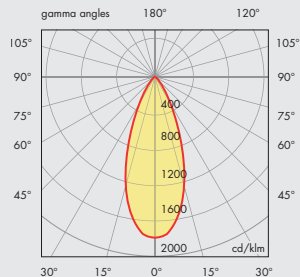

kit ecomini 13°

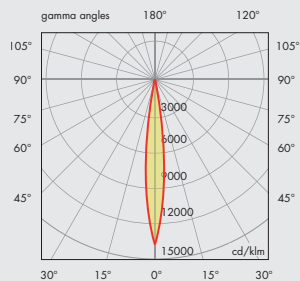

kit ecomini 19°

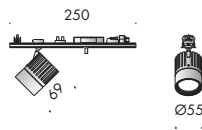
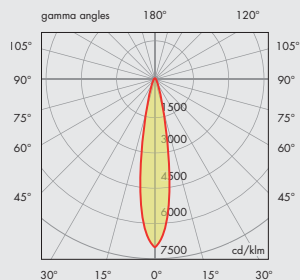

kit ecomini 36°

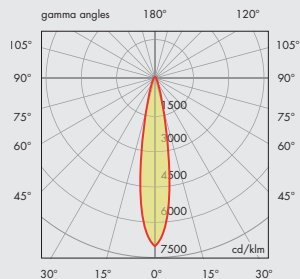

kit trentotto 41°	24Vdc							
--------------------------	--------------	--	--	--	--	--	--	--

Vb9.194.230.27 argento opaco · matt silver 2700K 41° 0,2

Vb9.194.231.27 bianco V 2700K 41° 0,2

Vb9.194.229.27 nero55 2700K 41° 0,2

Ra	R9	ies tm-30		sdc	mA	V _{f (min)}	lm	W	lm/W	
95	95	Rf 95	Rg 100	step 2	350	16,0	544	5,6	97	A+
cd040	les6	Ta25 °C		vita media · average life		50000 h	L70	B10		

Vb9.194.230.30 argento opaco · matt silver 3000K 41° 0,2

Vb9.194.231.30 bianco V 3000K 41° 0,2

Vb9.194.229.30 nero55 3000K 41° 0,2

Ra	ies tm-30		sdc	mA	V _{f (min)}	lm	W	lm/W	
95	Rf 92	Rg 100	step 2	350	17	455	6	76	A+
cd011	les6	Ta25 °C		vita media · average life		50000 h	L70	B10	

kit eco mini 13°	24Vdc							
-------------------------	--------------	--	--	--	--	--	--	--

Vb9.194.201.27 argento opaco · matt silver 2700K 13° 0,4

Vb9.194.202.27 bianco V 2700K 13° 0,4

Vb9.194.203.27 nero55 2700K 13° 0,4

Ra	R9	ies tm-30		sdc	mA	V _{f (min)}	lm	W	lm/W	
95	95	Rf 95	Rg 100	step 2	700	16,5	1026	11,6	89	A+
cd040	les6	Ta25 °C		vita media · average life		50000 h	L70	B10		

Vb9.194.201.30 argento opaco · matt silver 3000K 13° 0,4

Vb9.194.202.30 bianco V 3000K 13° 0,4

Vb9.194.203.30 nero55 3000K 13° 0,4

Ra	ies tm-30		sdc	mA	V _{f (min)}	lm	W	lm/W	
95	Rf 92	Rg 100	step 2	700	17,8	826	12,4	66	A
cd011	les6	Ta25 °C		vita media · average life		50000 h	L70	B10	

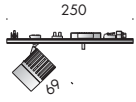

kit eco mini 19°		24Vdc		IP20		☆ CE		i	
Vb9.194.205.27	argento opaco · matt silver			2700K	19°	0,4			
Vb9.194.206.27	bianco V			2700K	19°	0,4			
Vb9.194.207.27	nero55			2700K	19°	0,4			
Ra	ies tm-30		sdc	mA	V _{f (min)}	lm	W	lm/W	
95	Rf 92	Rg 100	step 2	700	18,2	1000	12,7	79	A
ce000	les9 ●	Ta25 °C		vita media · average life		50000 h	L70	B10	

Vb9.194.205.30	argento opaco · matt silver			3000K	19°	0,4			
Vb9.194.206.30	bianco V			3000K	19°	0,4			
Vb9.194.207.30	nero55			3000K	19°	0,4			

Ra	ies tm-30		sdc	mA	V _{f (min)}	lm	W	lm/W	
95	Rf 92	Rg 100	step 2	700	18,2	1075	12,7	85	A+
ce001	les9 ●	Ta25 °C		vita media · average life		50000 h	L70	B10	

kit eco mini 36°		24Vdc		IP20		☆ CE		i	
Vb9.194.208.27	argento opaco · matt silver			2700K	36°	0,4			
Vb9.194.209.27	bianco V			2700K	36°	0,4			
Vb9.194.210.27	nero55			2700K	36°	0,4			
Ra	ies tm-30		sdc	mA	V _{f (min)}	lm	W	lm/W	
95	Rf 92	Rg 100	step 2	700	18,2	1000	12,7	79	A
ce000	les9 ●	Ta25 °C		vita media · average life		50000 h	L70	B10	

Vb9.194.208.30	argento opaco · matt silver			3000K	36°	0,4			
Vb9.194.209.30	bianco V			3000K	36°	0,4			
Vb9.194.210.30	nero55			3000K	36°	0,4			

Ra	ies tm-30		sdc	mA	V _{f (min)}	lm	W	lm/W	
95	Rf 92	Rg 100	step 2	700	18,2	1075	12,7	85	A+
ce001	les9 ●	Ta25 °C		vita media · average life		50000 h	L70	B10	

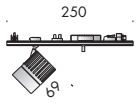

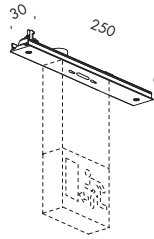

kit trasparenze 100

CE ⓘ

Vb9.194.220	argento opaco · matt silver	250mm	0,2
Vb9.194.221	bianco V	250mm	0,2
Vb9.194.222	nero55	250mm	0,2

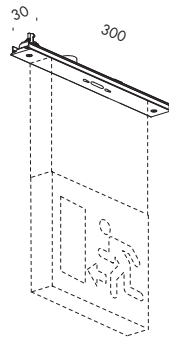

kit trasparenze 250

CE ⓘ

Vb9.194.223	argento opaco · matt silver	300mm	0,2
Vb9.194.224	bianco V	300mm	0,2
Vb9.194.225	nero55	300mm	0,2

kit trasparenze 100

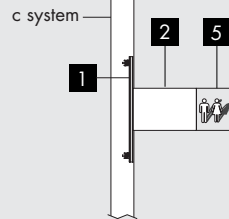
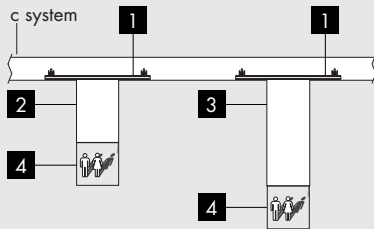

kit trasparenze 250

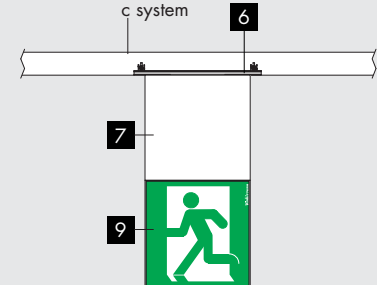

1 Vb9.194.220/221/222

2 trasparenze 100x150

3 trasparenze 100x250

4 segnaletica verticale 100
vertical sign system

5 segnaletica orizzontale 100
horizontal sign system

6 Vb9.194.223/224/225

7 trasparenze 250x250

nota: nel c system non è possibile installare kit trasparenze 250x500
note: in the c system is not possible to install kit trasparenze 250x500



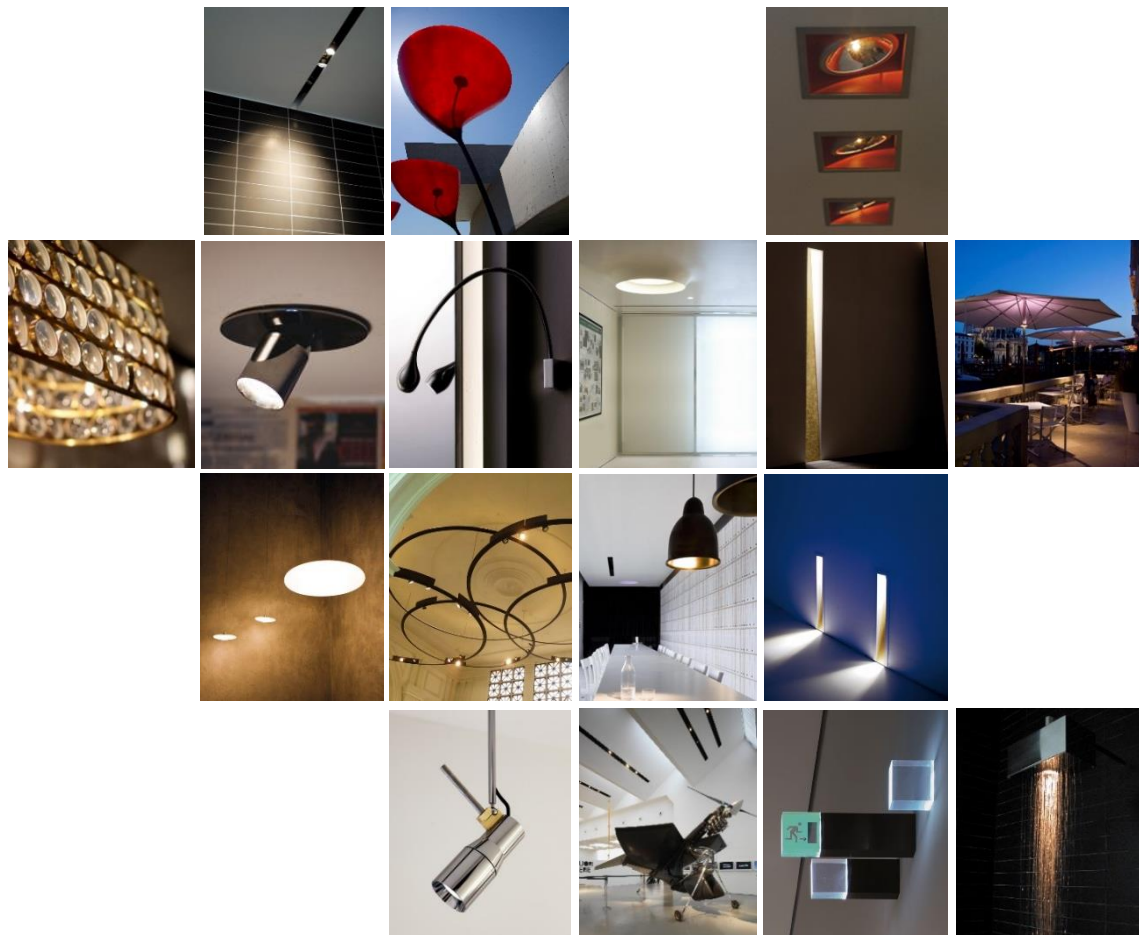

Subscribe To Our Newsletter



**Distributor for Viabizzuno
Architectural Lighting Solutions**

Web: www.cirruslighting.co.uk

Email: sales@cirruslighting.co.uk

Tel: 0207 193 2175

Fax: 0207 193 3175

