



*Viabizzuno strada principale della frazione di bizzuno in provincia di ravenna dove tra la casa del popolo e la parrocchia, al n°17, sono nato il ventuno luglio millenovecentocinquantacinque. da qui nasce il nome della fabbrica di produzione fondata nel millenovecentonovantaquattro rappresentata da uno spazio bianco attraversato da due linee. una verticale, rigorosa, essenziale, equilibrata: la luce per la luce; ed una inclinata, irriverente nello spazio, ironica, fuori dagli schemi: la luce per la forma. distinte ma complementari si fondono in un unico nome: Viabizzuno.*

*marionanni*

Viabizzuno is the name of the main road of the small village bizzuno located in the province of ravenna, where I was born on the twenty-first july nineteenfiftyfive at n°17, between the 'casa del popolo' and the local parish church. from here the name of the factory founded in nineteen ninety-four represented by a white space intersected by two lines. one vertical, well balanced, logical, essential: the light for the light. the other one dynamic, irreverent, ironic: the light for the form. separate and yet complementary they cast in the same name: Viabizzuno.

prodotto  
product



schede tecniche  
technical data sheet



curve fotometriche  
photometric curves



modelli 3d per i tuoi render  
3d models for your render



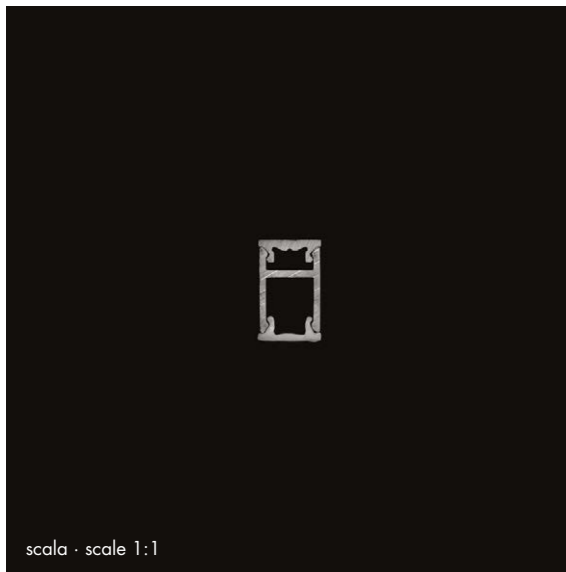

scala · scale 1:1

**apparecchio di illuminazione a parete o soffitto per interni IP20.**  
**realizzato in estruso di alluminio ossidato 13x8mm di sezione ad H, con lunghezze fino a 2110mm con un passo di 100mm.**  
**un lato del profilo si fissa ad un secondo estruso che funge da staffa di fissaggio agevolandone l'installazione.**  
**diffusore in policarbonato satinato della stessa lunghezza del profilo.**  
**cablato con sorgente elettronica lineare con limitatore di corrente integrato, 3000K Ra95 13W/m fino a 27,3W 2620lm. predisposto all'estremità con connettori amp2 maschio e femmina.**  
**alimentatore in tensione costante 24vdc escluso, da installare remoto.**  
**accessori: tappi di chiusura.**  
**finiture: argento opaco.**

**IP20 rated wall or ceiling light fitting for indoor use.**  
**made of 13x8mm oxidised aluminium extrusion, with H section, length up to 2110mm with a 100mm pitch.**  
**a side of the profile can be fixed to a second extrusion that serves as a fixing bracket for an easier installation.**  
**frosted polycarbonate diffuser having the same length of the profile.**  
**wired with a 3000K Ra95 13W/m up to 27.3W 2620lm linear led source with integrated current limiter, fitted with amp2 female or male connectors at the end.**  
**24Vdc constant voltage power supply not included, to be installed remotely.**  
**accessories: closing cups.**  
**finish: matt silver.**

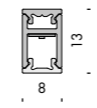

13x8 e entra	24Vdc	IP20	IP20	IP20	IP20	IP20
<b>Vb6.204.31</b>	argento opaco · matt silver	3000K	1,3W	110mm	0,04	
<b>Vb6.204.32</b>	argento opaco · matt silver	3000K	2,6W	210mm	0,07	
<b>Vb6.204.33</b>	argento opaco · matt silver	3000K	3,9W	310mm	0,1	
<b>Vb6.204.34</b>	argento opaco · matt silver	3000K	5,2W	410mm	0,1	
<b>Vb6.204.35</b>	argento opaco · matt silver	3000K	6,5W	510mm	0,2	
<b>Vb6.204.36</b>	argento opaco · matt silver	3000K	7,8W	610mm	0,2	
<b>Vb6.204.37</b>	argento opaco · matt silver	3000K	9,1W	710mm	0,2	
<b>Vb6.204.38</b>	argento opaco · matt silver	3000K	10,4W	810mm	0,3	
<b>Vb6.204.39</b>	argento opaco · matt silver	3000K	11,7W	910mm	0,3	
<b>Vb6.204.40</b>	argento opaco · matt silver	3000K	13W	1010mm	0,3	
<b>Vb6.204.41</b>	argento opaco · matt silver	3000K	14,3W	1110mm	0,4	
<b>Vb6.204.42</b>	argento opaco · matt silver	3000K	15,6W	1210mm	0,4	
<b>Vb6.204.43</b>	argento opaco · matt silver	3000K	16,9W	1310mm	0,4	
<b>Vb6.204.44</b>	argento opaco · matt silver	3000K	18,2W	1410mm	0,5	
<b>Vb6.204.45</b>	argento opaco · matt silver	3000K	19,5W	1510mm	0,5	
<b>Vb6.204.46</b>	argento opaco · matt silver	3000K	20,8W	1610mm	0,5	
<b>Vb6.204.47</b>	argento opaco · matt silver	3000K	22,1W	1710mm	0,5	
<b>Vb6.204.48</b>	argento opaco · matt silver	3000K	23,4W	1810mm	0,6	
<b>Vb6.204.49</b>	argento opaco · matt silver	3000K	24,7W	1910mm	0,6	
<b>Vb6.204.50</b>	argento opaco · matt silver	3000K	26W	2010mm	0,7	
<b>Vb6.204.51</b>	argento opaco · matt silver	3000K	27,3W	2110mm	0,7	

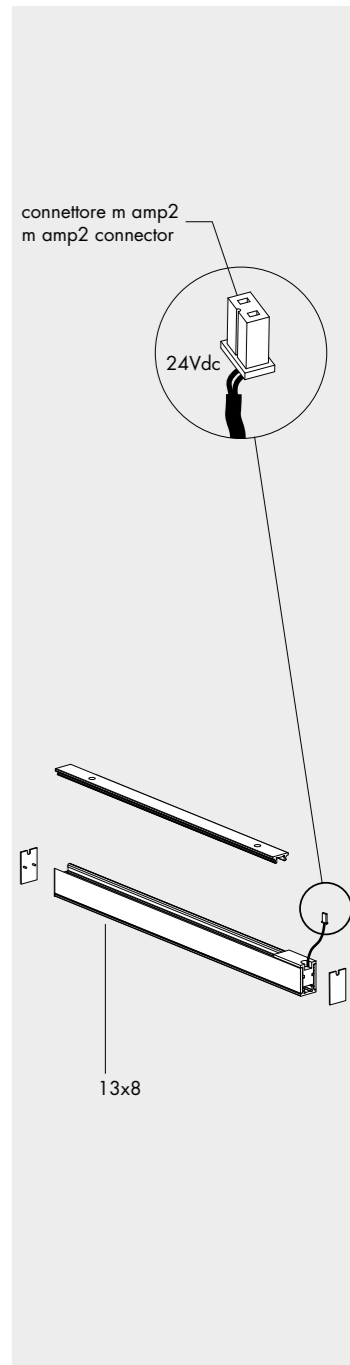

Ra	R9	ies tm/30	sdc	Vf	lm/m	W/m	lm/W
95	90	Rf 93 Rg 102	step 2	24	1250	13	96
V0001	5,9	Ta25 °C	vita media · average life	50000 h	L80	B10	

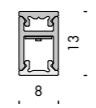
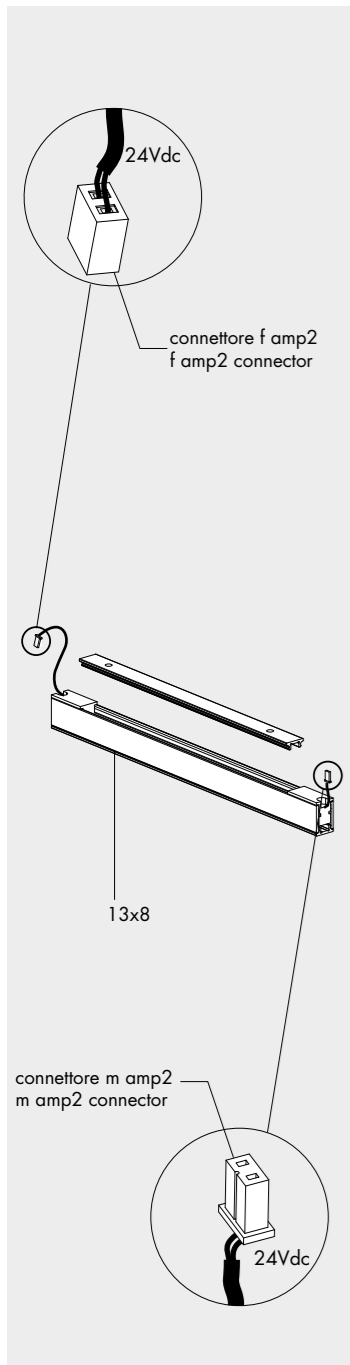

**13x8 e-e entra-esce** 24Vdc

<b>Vb6.204.01</b>	argento opaco · matt silver	3000K	1,3W	110mm	0,04
<b>Vb6.204.02</b>	argento opaco · matt silver	3000K	2,6W	210mm	0,07
<b>Vb6.204.03</b>	argento opaco · matt silver	3000K	3,9W	310mm	0,1
<b>Vb6.204.04</b>	argento opaco · matt silver	3000K	5,2W	410mm	0,1
<b>Vb6.204.05</b>	argento opaco · matt silver	3000K	6,5W	510mm	0,2
<b>Vb6.204.06</b>	argento opaco · matt silver	3000K	7,8W	610mm	0,2
<b>Vb6.204.07</b>	argento opaco · matt silver	3000K	9,1W	710mm	0,2
<b>Vb6.204.08</b>	argento opaco · matt silver	3000K	10,4W	810mm	0,3
<b>Vb6.204.09</b>	argento opaco · matt silver	3000K	11,7W	910mm	0,3
<b>Vb6.204.10</b>	argento opaco · matt silver	3000K	13W	1010mm	0,3
<b>Vb6.204.11</b>	argento opaco · matt silver	3000K	14,3W	1110mm	0,4
<b>Vb6.204.12</b>	argento opaco · matt silver	3000K	15,6W	1210mm	0,4
<b>Vb6.204.13</b>	argento opaco · matt silver	3000K	16,9W	1310mm	0,4
<b>Vb6.204.14</b>	argento opaco · matt silver	3000K	18,2W	1410mm	0,5
<b>Vb6.204.15</b>	argento opaco · matt silver	3000K	19,5W	1510mm	0,5
<b>Vb6.204.16</b>	argento opaco · matt silver	3000K	20,8W	1610mm	0,5
<b>Vb6.204.17</b>	argento opaco · matt silver	3000K	22,1W	1710mm	0,6
<b>Vb6.204.18</b>	argento opaco · matt silver	3000K	23,4W	1810mm	0,6
<b>Vb6.204.19</b>	argento opaco · matt silver	3000K	24,7W	1910mm	0,6
<b>Vb6.204.20</b>	argento opaco · matt silver	3000K	26W	2010mm	0,7
<b>Vb6.204.21</b>	argento opaco · matt silver	3000K	27,3W	2110mm	0,7

Ra	R9	ies tm/30		sdc	Vf	lm/m	W/m	lm/W
95	90	Rf 93	Rg 102	step 2	24	1250	13	96
V0001	5,9	Ta25 °C		vita media · average life	50000 h	L80	B10	

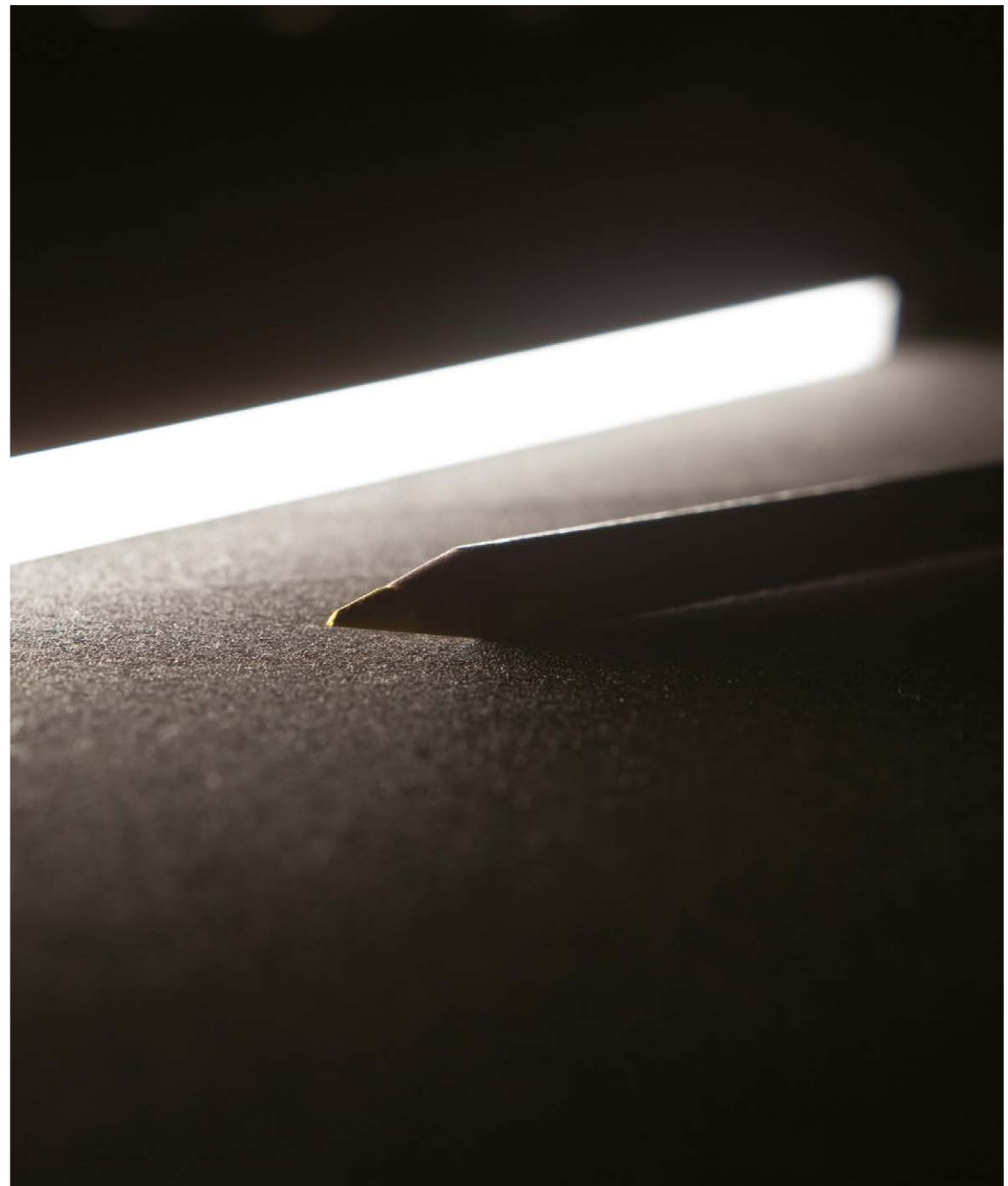
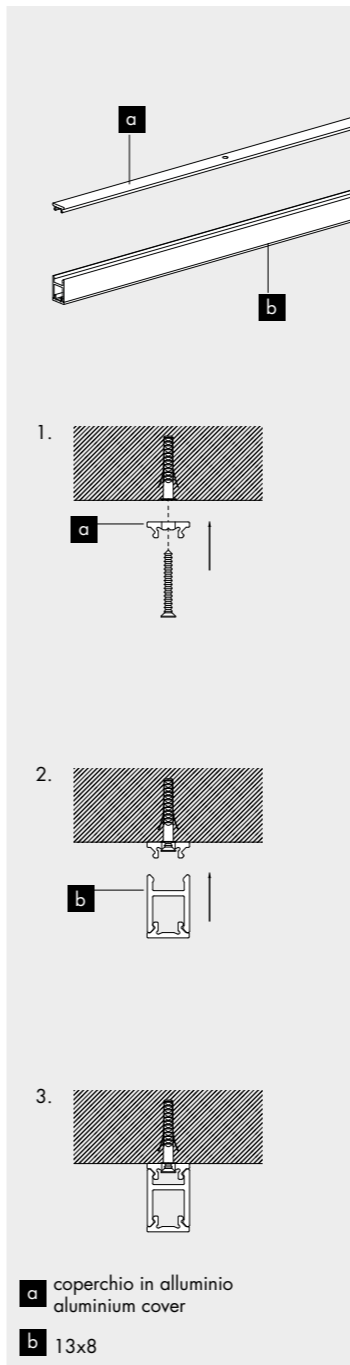

**13x8** ☆ CE i

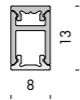

<b>f6.204.91</b>	profilo vuoto + policarbonato empty profile + polycarbonate	4 pz · pcs	3000mm	2
<b>f6.204.90</b>	profilo vuoto + policarbonato empty profile + polycarbonate	100 pz · pcs	3000mm	50

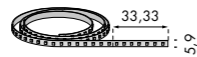

**linea di luce Ra95/13** 24Vdc A B C D ☆ CE i

**Vb6.250.121** 2700K 6000mm 0,6

Ra	R9	ies tm/30		sdcm	Vf	lm/m	W/m	lm/W	
95	90	Rf 90	Rg 98	step 2	24	1200	13	92	F
V0000	5,9	Ta25 °C		vita media · average life		50000 h	L80 B10		

**Vb6.250.122** 3000K 6000mm 0,6

Ra	R9	ies tm/30		sdcm	Vf	lm/m	W/m	lm/W	
95	90	Rf 93	Rg 102	step 2	24	1250	13	96	F
V0001	5,9	Ta25 °C		vita media · average life		50000 h	L80 B10		

**Vb6.250.123** 4000K 6000mm 0,6

Ra	R9	ies tm/30		sdcm	Vf	lm/m	W/m	lm/W	
95	95	Rf 90	Rg 98	step 2	24	1300	13	100	F
V0003	5,9	Ta25 °C		vita media · average life		50000 h	L80 B10		

**Vb6.250.124** 5000K 5000K 6000mm 0,6

Ra	R9	ies tm/30		sdcm	Vf	lm/m	W/m	lm/W	
95	95	Rf 90	Rg 98	step 2	24	1300	13	100	F
V0005	5,9	Ta25 °C		vita media · average life		50000 h	L80 B10		

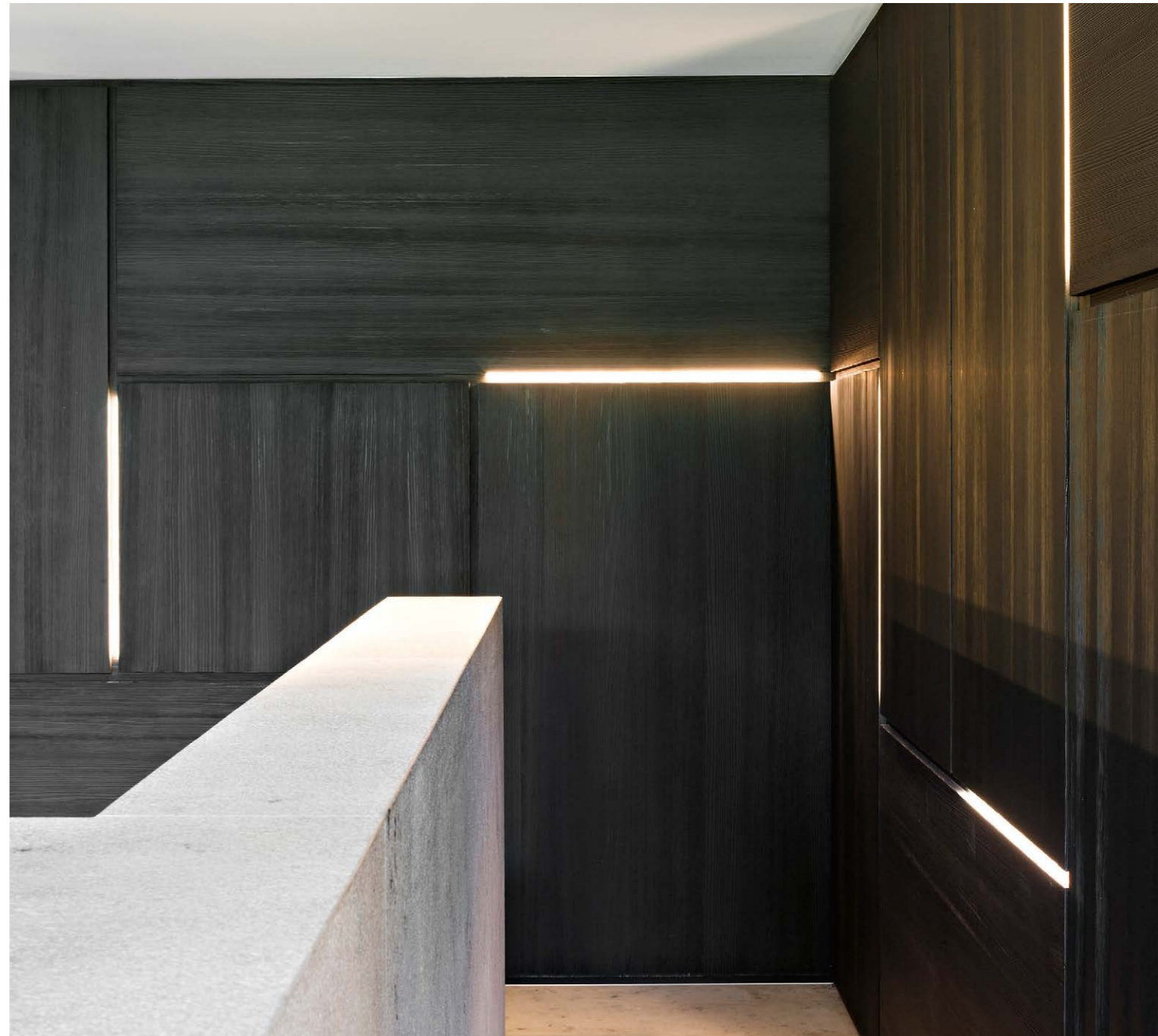

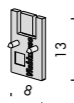
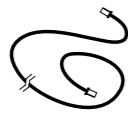

cavi con connettore femmina amp2. cables with amp2 female connector. IP20 ☆ CE #

f9.204.90 150mm 0,01

cavi con connettori m/f amp2. cables with m/f amp2 connectors. IP20 ☆ CE #

f9.204.91 2000mm 0,3

accessori. accessories. ☆ CE #

f9.204.80 tappi di chiusura · closing caps 100 pz · pcs 0,1

f9.204.81 tappi di chiusura · closing caps 10 pz · pcs 0,01

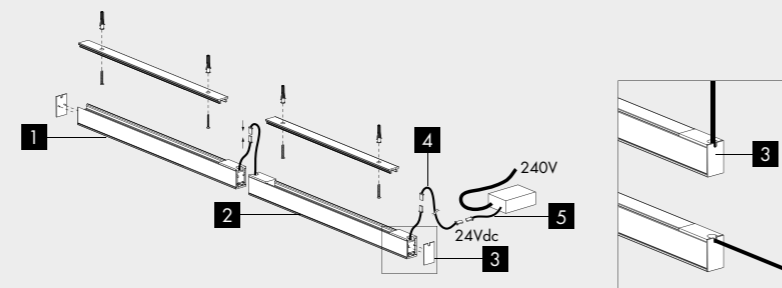
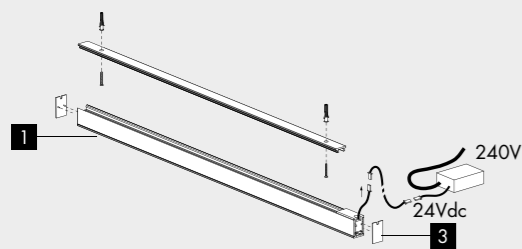
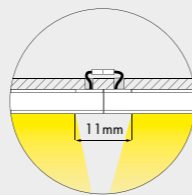
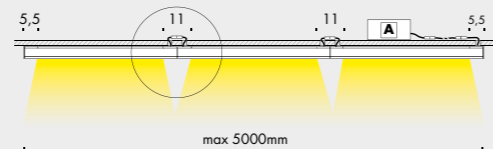
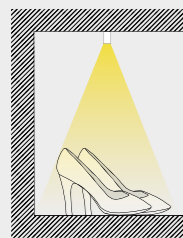

- 1** 13x8  
n.1 connettore maschio amp2 · male connector
- 2** 13x8  
n.2 connettori m/f amp2 · connectors
- 3** tappo di chiusura incluso  
end cap included



- 4** f9.204.91 l.2000mm cavo · cable  
n.2 connettori m/f amp2 · connectors
- 5** f9.204.90 l.150mm cavo · cable  
n.1 connettore femmina amp2 · connector



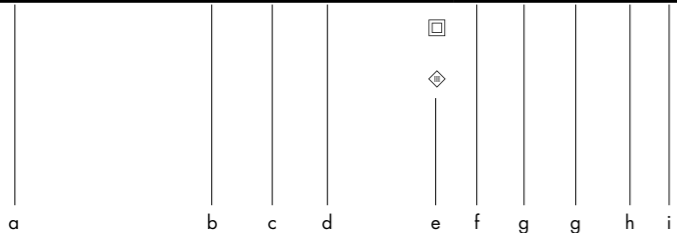

## lettura delle tabelle tecniche how to read technical tables

xxxxxxxxxxxxxxxx 230V 50-60Hz A IP66   CE 



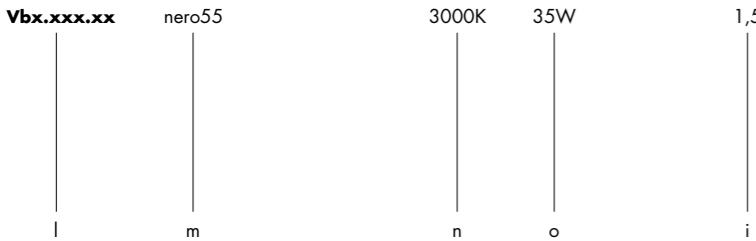

xxxxxxxxxxxxxxxx 230V 50-60Hz A IP66   CE 

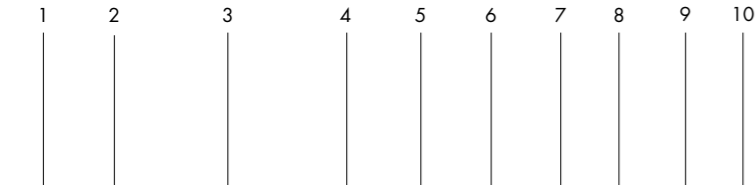

componenti. components. IK10 CE 

accessori. accessories. IK10 CE 



Ra	R9	ies tm/30		sdc	Vf	lm/m	W/m	lm/W	
95	90	Rf 90	Rg 98	step 2	24	1200	13	92	F
V0000	5,9 	Ta25 °C		vita media · average life	50000 h	L80	B10		



bandella tecnica. posizioni standard simbologie.  
data plate. standard arrangement of symbols.

a	nome apparecchio di illuminazione · light fitting name
b	tensione di alimentazione · supply rating (Volt)
c	frequenza di alimentazione · supply frequency (Hertz)
d	alimentatore incluso o escluso · power supply included or not included
e	classe di isolamento · insulation class
f	grado di protezione · protection degree
g	marchio di certificazione · safety and quality standards certification
h	conforme alle direttive europee produced in compliance with EC directives
i	peso netto · net weight (kg)
l	codice · code
m	finitura · finish
n	temperatura colore sorgente elettronica colour temperature led source (Kelvin)
o	potenza della sorgente · source power (Watt)

componenti. identifica tutti gli elementi indispensabili per la corretta funzionalità e installazione dell'apparecchio di illuminazione.  
components. includes all items that are essential to the correct operation and installation of the light fitting.



























accessori. si riferisce alle ulteriori parti installabili sull'apparecchio.  
accessories. refers to items that can be added to the light fitting.

1	indice di resa cromatica · colour rendering index
2	indice di resa del rosso · red colour rendering index
3	Rf indice di fedeltà colore · colour fidelity index Rg indice di saturazione colore · color gamut index
4	step di macadam · macadam step
5	corrente di alimentazione · power supply current
6	tensione di alimentazione · power supply voltage
7	flusso luminoso · light flux
8	potenza della sorgente · source power
9	efficienza della sorgente · source efficiency
10	classe di efficienza energetica · efficiency class
11	codice sorgente elettronica Viabizzuno · Viabizzuno led source code
12	superficie emittente · light emitting surface (mm)
13	% flusso residuo a fine vita · end life % flux
14	% consentita sotto limite · allowed % under limit

## gradi di protezione protection degrees

IPX0	non protetto no protection	IK01	nessuna protezione no protection
IPX1	protetto contro la caduta verticale di gocce d'acqua protected against water drops falling vertically	IK01	protetto contro l'energia d'urto 0,15J protected against collision energy
IPX2	protetto contro la caduta di gocce con inclinazione max 15° protected against water drops max inclination 15°	IK02	protetto contro l'energia d'urto 0,2J protected against collision energy
IPX3	protetto contro la caduta di gocce con inclinazione max 60° protected against water drops max inclination 60°	IK03	protetto contro l'energia d'urto 0,35J protected against collision energy
IP0X	non protetto no protection	IK04	protetto contro l'energia d'urto 0,5J protected against collision energy
IP1X	contro corpi estranei >50 mm protection against solid objects	IK05	protetto contro l'energia d'urto 0,7J protected against collision energy
IP2X	contro corpi estranei >12 mm protection against solid objects	IK06	protetto contro l'energia d'urto 1J protected against collision energy
IP3X	contro corpi estranei >2,5 mm protection against solid objects	IK07	protetto contro l'energia d'urto 2J protected against collision energy
IP4X	contro corpi estranei >1 mm protection against solid objects	IK08	protetto contro l'energia d'urto 5J protected against collision energy
IP5X	protezione da polvere dust-protected	IK09	protetto contro l'energia d'urto 10J protected against collision energy
IP6X	stagno alla polvere dust-proof	IK10	protetto contro l'energia d'urto 20J protected against collision energy
IPX4	protetto contro spruzzi d'acqua protected against sprinkling water		
IPX5	protetto contro getti d'acqua protected against water jets		
IPX6	protetto contro inondazioni rotected against flooding		
IPX7	per breve immersione protected against brief immersions		
IPX8	per immersione prolungata protected against long immersion		

## legenda simboli symbols key

	<i>tavolo</i> · table
	<i>terra</i> · floor standing
	<i>soffitto</i> · ceiling
	<i>parete</i> · wall
	<i>sospensione</i> · suspension
	<i>binario</i> · track
	<i>incasso</i> · recessed
	<i>scomparsa totale</i> · fully concealed
	<i>segnaletica+emergenza</i> · signalling system+emergency
	<i>portatili autoalimentati a batteria</i> · portable self-powered with battery
	<i>sistemi</i> · systems
	<i>palo</i> · pole
	<i>paletto</i> · bollard
	<i>seduta</i> · sitting
	<i>disponibile su</i> · available on <i>Viabizzuno applight</i> <i>www.Viabizzuno.com</i> <i>Viabizzuno online</i>
	<i>classe I. solo isolamento fondamentale, le parti conduttrici accessibili sono collegate ad un conduttore di terra. messa a terra tassativa</i> class I. only basic insulation, accessible conductors are earthed. earthing compulsory
	<i>classe II. all'isolamento principale è aggiunto un secondo isolamento oppure ai due isolamenti è sostituito un isolamento rinforzato. messa a terra esclusa</i> class II. basic insulation plus second insulation or both are replaced by reinforced insulation. earthing excluded
	<i>classe III. alimentazione effettuata con bassissima tensione di sicurezza; sono escluse tensioni superiori a 50V-50Hz. messa a terra non prevista.</i> class III. very low safety supply tension; not to be used over 50V-50Hz. earthing excluded.
	<i>prodotto conforme alle direttive europee</i> · produced in compliance with ec directives
	<i>marchio di certificazione europea. certifica che il prodotto è conforme alle norme europee sulla sicurezza</i> component approved for north american market and suitable to be used and approved as part of a more complex system
	<i>componente certificato per il mercato nord americano idoneo ad essere utilizzato e valutato come parte di in un sistema più complesso</i> component approved for north american market and suitable to be used and approved as part of a more complex system
	<i>apparecchio di illuminazione approvato da kema</i> · kema approved light fitting
	<i>prodotto conforme agli standard presenti nel regno unito che regolamentano la sicurezza e la qualità dell'acqua</i> · product complies with uk standards set out by water regulations
	<i>apparecchio di illuminazione certificato secondo le normative vigenti in polonia che regolamentano i dispositivi di sicurezza antincendio</i> certified light fitting according to the regulations about devices for fire safety in force in poland
	<i>prodotto idoneo per essere commercializzato nel mercato cinese</i> · product suitable for the china market
	<i>prodotto finito idoneo per essere commercializzato nel mercato nord americano</i> · listed product suitable for the north american market
	<i>apparecchio di illuminazione certificato per il mercato cinese</i> light fitting certified for china market

	<i>vetro opalino</i> · opal glass
	<i>vetro sabbiato</i> · sanded glass
	<i>vetro nero fumè</i> · black smoke glass
	<i>vetro trasparente</i> · transparent glass
	<i>vetro bianco latte</i> · white milk glass
	<i>cristallo</i> · crystal
	<i>policarbonato opalino</i> · opal polycarbonate diffuser
	<i>carrabile</i> · drive over
	<i>alimentatore incluso</i> · power supply included
	<i>alimentatore escluso</i> · power supply not included
	<i>alimentatore remoto incluso</i> · remote power supply included
	<i>alimentatore elettronico con controllo intelligente incluso</i> · electronic power supply with smart control included
	<i>alimentatore elettronico con controllo intelligente incluso, da installare remoto</i> · electronic power supply with smart control included, to be installed remotely
	<i>alimentatore a spina incluso</i> · plug power supply included
	<i>trasformatore incluso</i> · transformer included
	<i>trasformatore escluso</i> · transformer not included
	<i>kit di cablaggio</i> · wiring kit
	<i>kit di cablaggio escluso</i> · wiring kit not included
	<i>lampadina con sorgente elettronica led, ad incandescenza, alogena o fluorescente inclusa.</i> bulb with led electronic source, incandescent, halogen or fluorescent included.
	<i>lampadina con sorgente elettronica led, ad incandescenza, alogena o fluorescente esclusa.</i> bulb with led electronic source, incandescent, halogen or fluorescent not included.
	<i>propulsore dinamico n55 incluso</i> · included
	<i>possibilità di combinazione tra interfaccia n55, propulsore dinamico n55 e lampadina n55</i> · possible combination between n55 interface, propulsore dinamico n55 and n55 bulb
	<i>attenzione: sorgente luminosa led. non guardare mai direttamente a occhio nudo</i> · attention: led light source. never look straight without eye protection
	<i>flicker free compatibile con fotocamere digitali</i> · flicker free digital camera friendly
<b>l.d.</b>	<i>luce diretta</i> · direct light
<b>l.i.</b>	<i>luce indiretta</i> · indirect light
<b>.d1</b>	<i>dimmerazione 1-10V</i> · 1-10V dimmable
<b>.d2</b>	<i>dimmerazione dali</i> · dimmable dali
<b>.SA</b>	<i>kit luce + emergenza sempre accese. attenzione: non è possibile installare nelle cassaforme laterizio</i> light kit + permanently lit emergency lamp. please note: cannot be installed in brickwork housing
<b>.SE</b>	<i>solo emergenza sempre accesa. attenzione: non è possibile installare nelle cassaforme laterizio</i> permanently lit emergency lamp only. please note: cannot be installed in brickwork housing
	<i>peso netto</i> · net weight (kg)