

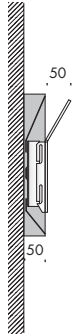

**apparecchio di illuminazione a parete o scomparsa totale per interni IP20.
realizzato in alluminio verniciato a polvere, può essere installato a parete o all'interno di
pareti in laterizio o cartongesso mediante apposita cassaforma.
cablato con sorgente elettronica biemissione 2700K Ra97 fino 11,9W 500mA 877lm.
alimentatore 220-240V 50-60Hz incluso, da installare remoto.
finiture: bianco V.**

**IP20 rated wall mounted or fully concealed light fitting for indoor use.
made of powder coated aluminium, it can be installed inside a brick or plasterboard wall
with his housing.
wired with 2700K Ra97 up to 11,9W 500mA 877lm bi-directional led source.
220-240V 50-60Hz power supply included, to be installed remotely.
finishes: bianco V.**

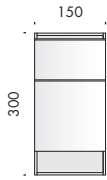



vela 240V 50-60Hz **AR** **IP20** **CE** **i**

Vb5.100.11.27 bianco V 2700K 6

Vb5.100.11.30 bianco V 3000K 6

I.d. (luce diretta - direct light)

Ra	R9	ies tm-30		sdc	mA	V _{f (min)}	lm	W	lm/W	
97	90	Rf 96	Rg 100	step 2	250	23,7	438	5,9	74	A+
					350	23,4	621	8,2	76	A
					500	23,7	877	11,9	74	A
dz010	10	Ta25 °C		vita media · average life		50000 h	L80	B10		

I.i. (luce indiretta - indirect light)

Ra	R9	ies tm-30		sdc	mA	V _{f (min)}	lm	W	lm/W	
97	90	Rf 96	Rg 100	step 2	250	23,7	438	5,9	74	A+
					350	23,4	621	8,2	76	A
					500	23,7	877	11,9	74	A
dz010	10	Ta25 °C		vita media · average life		50000 h	L80	B10		

accessori. accessories.

CE **i**

Vb9.100.81 cassafornia scomparsa totale laterizio e cartongesso
fully concealed brick and plaster housing 0,9

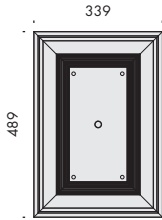

Vb5.100.11
installazione a parete

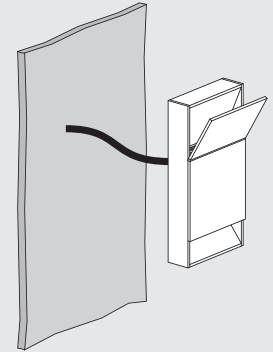

I.i.
luce indiretta
indirect light

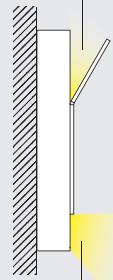

I.d.
luce diretta
direct light

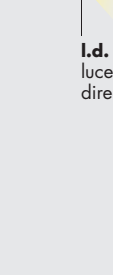

Vb9.100.81
cassaforma scomparsa totale laterizio e cartongesso
fully concealed brick and plaster housing

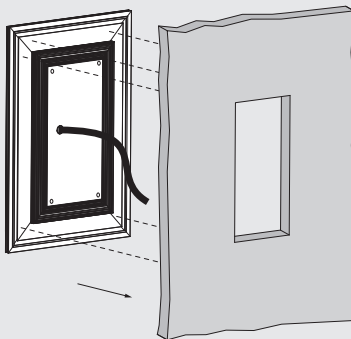
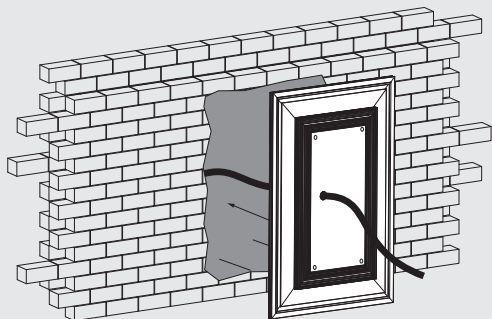

- 1 prevedere una nicchia nella muratura o nel cartongesso per l'incasso della cassaforma. posizionare la cassaforma nel foro facendo passare i cavi di alimentazione all'interno di essa e procedere all'ultimazione della parete con finitura dell'intonaco a filo della cassaforma.
attenzione: tenere pulito l'interno della cassaforma.
form a recess in the wall for the housing. place the housing in the hole, inserting the power cables and complete the wall with a plaster finish flush with the housing.
please note: keep the inside of the housing clean.

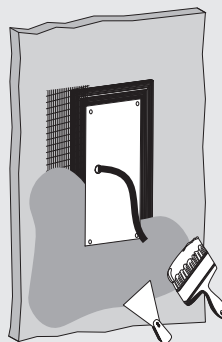
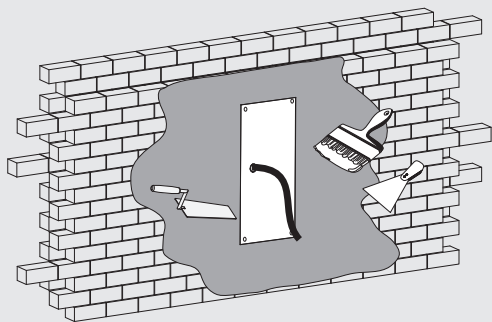

- 2 stuccare, rasare e verniciare
point, skim and paint

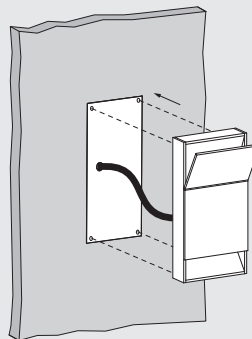
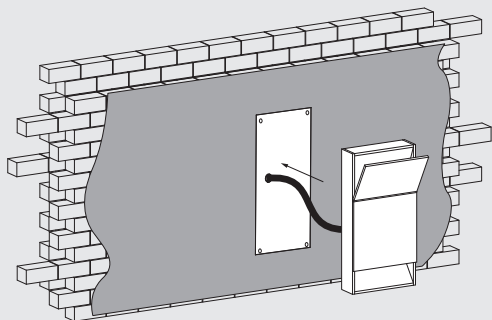

- 3 installare il sistema di illuminazione
install the lighting system

250/350/500mA

250/350/500mA





Subscribe To Our Newsletter



**Distributor for Viabizzuno
Architectural Lighting Solutions**

Web: www.cirruslighting.co.uk

Email: sales@cirruslighting.co.uk

Tel: 0207 193 2175

Fax: 0207 193 3175

