



brevettato · patented

*sistema modulare per interni.  
realizzato in estruso di alluminio ossidato, studiato per la distribuzione di cavi e altri  
componenti elettrici nella pavimentazione.*

*modelli:*

*aituoipiedi centrale 96 135x96mm 3000mm completo di coperchio calpestabile h.10mm filo  
pavimento,*

*aituoipiedi centrale 106 135x106mm 3000mm con coperchio h.10mm predisposto per  
alloggiare un rivestimento di spessore di 10mm (pietra, legno, marmo, ceramica),*

*aituoipiedi perimetrale 162 136,5x162mm 3000mm predisposto ad alloggiare  
l'apparecchio di illuminazione 13x8 per illuminare le pareti, da acquistare separatamente.  
il profilo estruso può essere sezionato per ottenere diverse altezze.*

*il coperchio può essere intervallato con degli sportelli per raggiungere facilmente impianti,  
prese ed altri componenti elettrici.*

*accessori: sportello cieco, testata di chiusura, giunti lineari, raccordi, cavi e prese di  
derivazione.*

*finiture: nero55.*

**modular system for indoor use.**

**made of oxidized extruded aluminium, designed for the distribution of cables and other  
floor electrical components.**

**versions:**

**aituoipiedi centrale 96 135x96mm 3000mm complete with h.10 mm lid that can be  
trampled and that is flush with the floor,**

**aituoipiedi centrale 106 135x106mm 3000mm with h.10mm lid designed for a 10mm thick  
coating (stone, wood, marble, ceramic),**

**aituoipiedi perimetrale 162 136.5x162mm 3000mm designed to accommodate 13x8 light  
fitting for wall lighting, to be purchased separately.**

**the extruded profile can be divided to obtain different heights.**

**the lid may be staggered with access lids to easily reach systems, sockets and other  
electrical components.**

**accessories: blind lid, end plate, straight joints, fittings, derivation cables and sockets.  
finishes: nero55.**



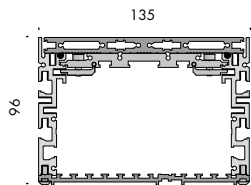

**aituoipiedi centrale 96**



**f6.223.02** nero55  
completo di coperchio · lid included

3000mm 22,4

**accessori. accessories.**

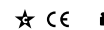

**f6.223.41** sportello di accesso al vano tecnico  
technical compartment door

280mm 1,1

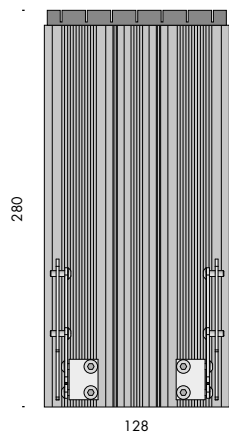

**f6.223.20** testata di chiusura · end plate

0,3

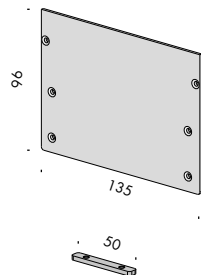

**f9.223.80** giunti lineari · linear joints

0,01

f6.223.02

vano tecnico  
technical compartment

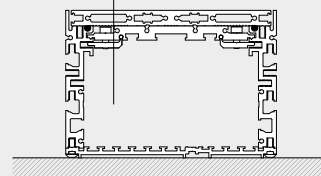

cemento  
concrete

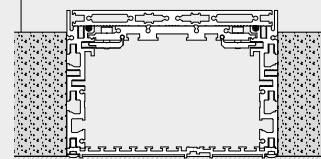

pavimentazione  
floor

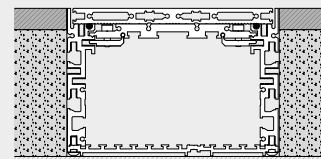
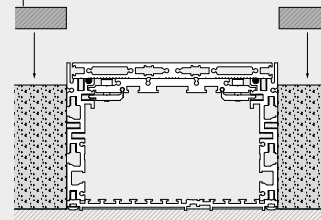

f6.223.01

vano tecnico  
technical compartment

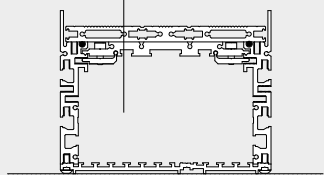

cemento  
concrete

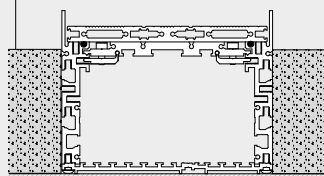

pavimentazione  
floor

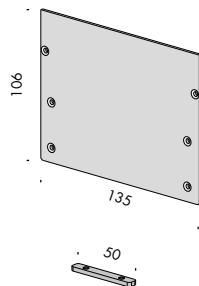
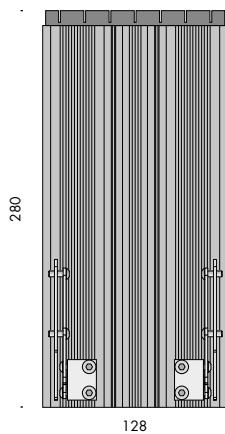
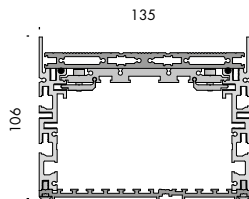
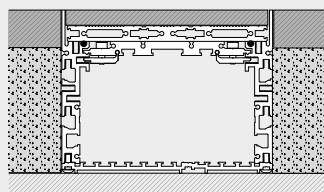
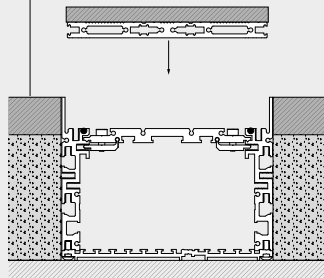

**aituoipiedi centrale 106**



**f6.223.01** nero55  
completo di coperchio · lid included

3000mm 22,4

**accessori. accessories.**



**f6.223.41** sportello di accesso al vano tecnico  
technical compartment door

280mm 1,1

**f6.223.17** testata di chiusura · end plate

0,3

**f9.223.80** giunti lineari · linear joints

4 pz · pcs 0,01



f6.223.03

vano tecnico  
technical compartment

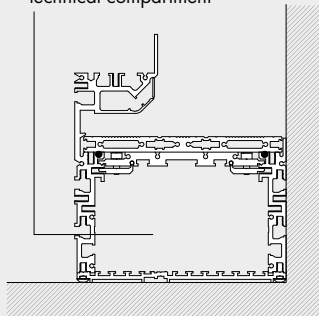

cemento  
concrete

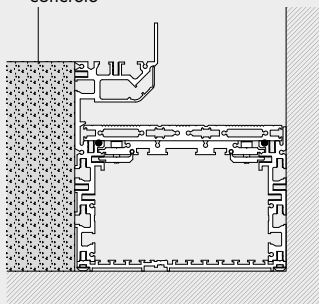

pavimentazione  
floor

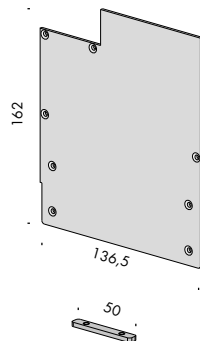
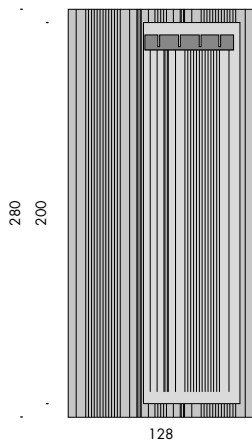
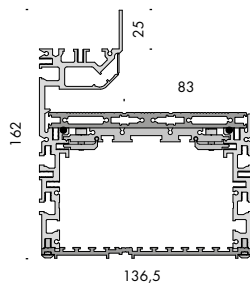
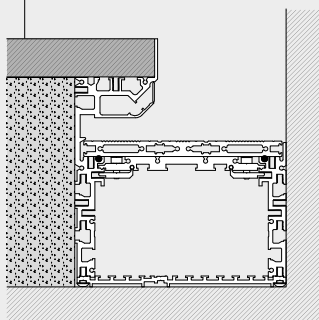

aiutoipiedi perimetrale 162



f6.223.03 nero55  
completo di coperchio · lid included

3000mm 25,8

accessori. accessories.

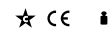

f6.223.42 sportello di accesso al vano tecnico  
technical compartment door

280mm 1,1

f6.223.19 testata di chiusura · end plate

0,3

f9.223.80 giunti lineari · linear joints

4 pz · pcs 0,01

possibilità di variazione altezza  
possibility of height variation

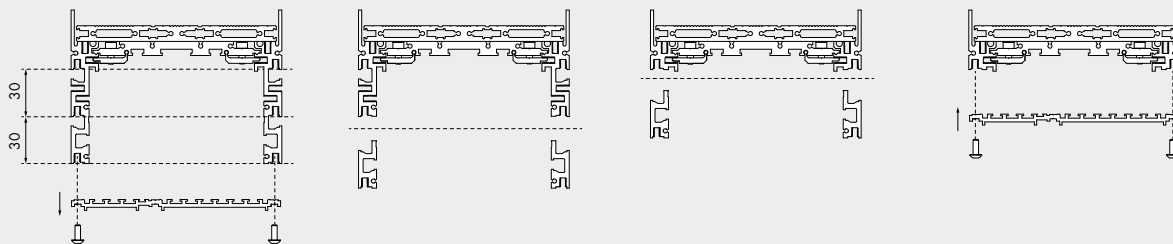

f6.223.01  
f6.223.02  
variazione altezza aiuoi piedi centrale  
height variation

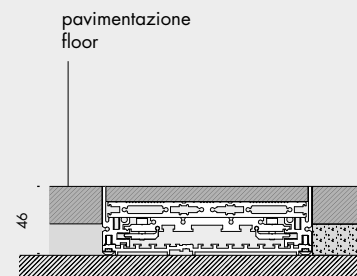
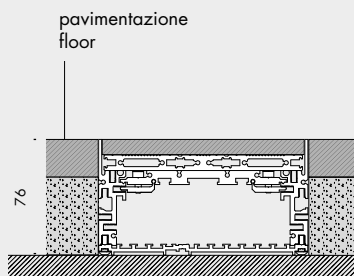
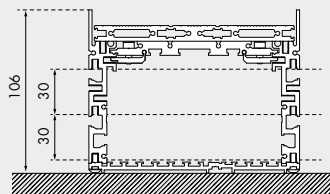

f6.223.03  
variazione altezza aiuoi piedi perimetrale  
height variation

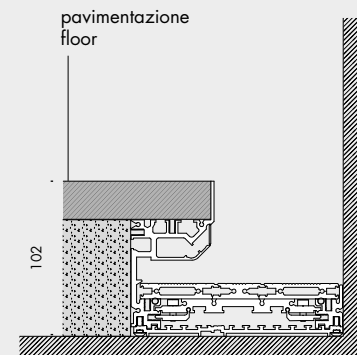
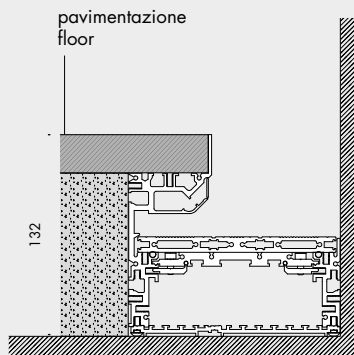
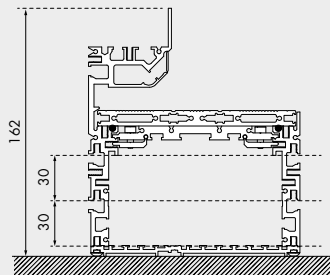

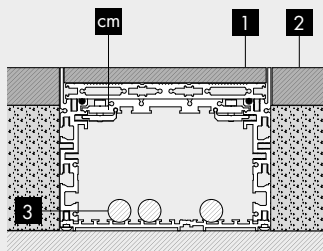

**cm** f6.223.01 aiutoipiedi centrale 106

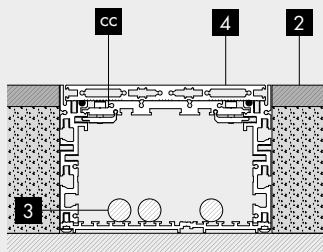

**cc** f6.223.02 aiutoipiedi centrale 96

**1** coperchio in alluminio o sportello di accesso al vano elettrico con finitura del pavimento (spessore max 10mm)  
aluminium lid or electric compartment door with finish floor (max 10mm thickness)

**2** pavimentazione  
floor

**3** cavi elettrici  
electric cables

**4** coperchio in alluminio o sportello di accesso al vano elettrico  
aluminium lid or electric compartment door

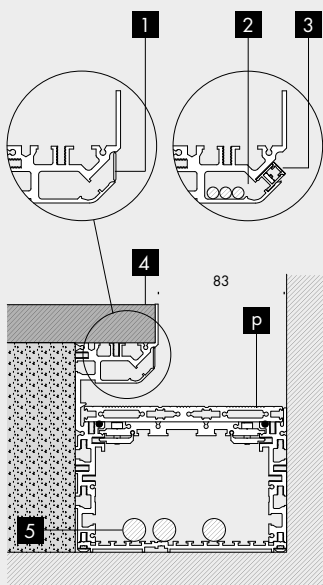

**p** f6.223.03 aiutoipiedi perimetrale 162

**1** linguetta removibile per alloggiare 13x8  
removable flap to house 13x8

**2** gola per passaggio cavi profilo 13x8  
conduit for 13x8 profile cables

**3** 13x8 pag.290

**4** pavimentazione (max 25mm di spessore)  
floor (max 25mm thickness)

**6** cavi elettrici  
electric cables

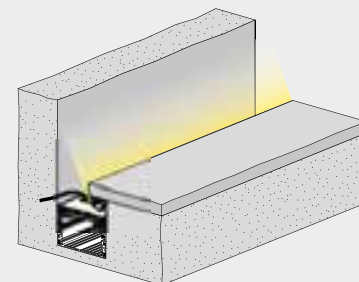
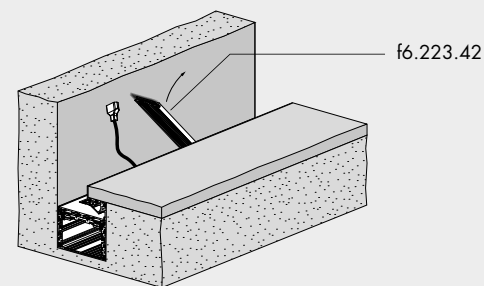
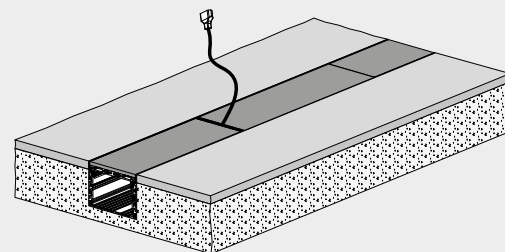
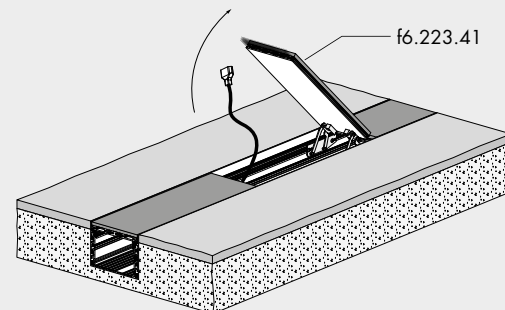





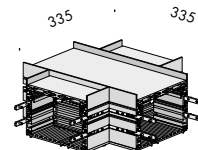
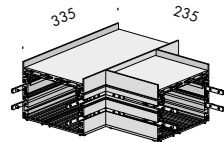
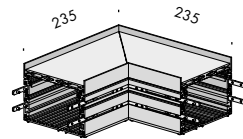
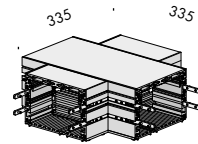
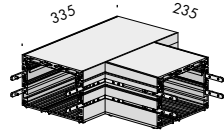
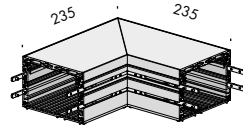

<b>raccordi centrali 96. central 96 couplers.</b>	★ CE ⓘ
---	--------

<b>f6.223.32</b>	raccordo L con coperchio a filo L coupler with flush lid	nero55	2,2
------------------	---	--------	-----

<b>f6.223.33</b>	raccordo T con coperchio a filo T coupler with flush lid	nero55	2,4
------------------	---	--------	-----

<b>f6.223.34</b>	raccordo + con coperchio a filo + coupler with flush lid	nero55	2,4
------------------	---	--------	-----

<b>raccordi centrali 106. central 106 couplers.</b>	★ CE ⓘ
---	--------

<b>f6.223.21</b>	raccordo L con coperchio ribassato L coupler with low lid	nero55	2,2
------------------	--	--------	-----

<b>f6.223.22</b>	raccordo T con coperchio ribassato T coupler with low lid	nero55	2,4
------------------	--	--------	-----

<b>f6.223.23</b>	raccordo + con coperchio ribassato + coupler with low lid	nero55	2,4
------------------	--	--------	-----

**raccordi perimetrali 162. perimeter 162 couplers.**

☆ CE ⓘ

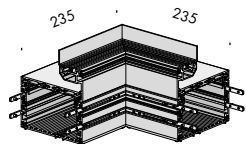

**f6.223.27** raccordo angolo interno L  
inside corner L coupler

nero55 2,9

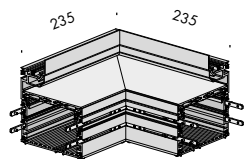

**f6.223.28** raccordo angolo esterno L  
outside corner L coupler

nero55 3,9



**raccordi perimetrali 162/centrali 96. perimeter 162/central 96 couplers. ☆ CE i**

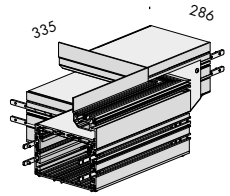

**f6.223.38** raccordo dx T con coperchio a filo  
right T coupler with flush lid      nero55      3,1

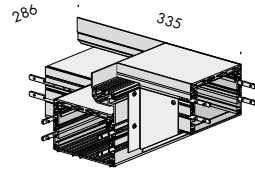

**f6.223.39** raccordo sx T con coperchio a filo  
left T coupler with flush lid      nero55      3,1

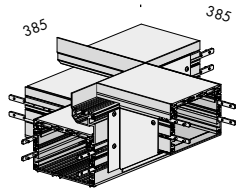

**f6.223.40** raccordo + con coperchio a filo  
+ coupler with flush lid      nero55      3,9

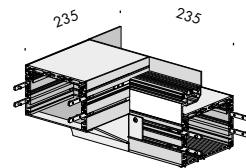

**f6.223.35** raccordo dx L con coperchio a filo  
right L coupler with flush lid      nero55      3,1

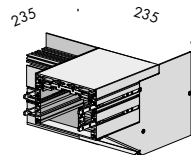

**f6.223.36** raccordo sx L con coperchio a filo  
left L coupler with flush lid      nero55      3,1

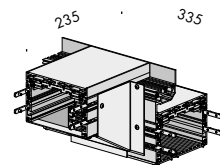

**f6.223.37** raccordo T con coperchio a filo  
T coupler with flush lid      nero55      3,1

**raccordi perimetrali 162/centrali 106. perimeter 162/central 106 couplers. ☆ CE ï**

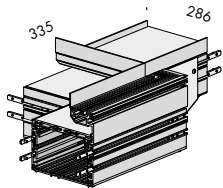

**f6.223.29** raccordo dx T con coperchio ribassato  
right T coupler with low lid      nero55      3,1

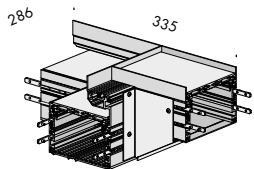

**f6.223.30** raccordo sx T con coperchio ribassato  
left T coupler with low lid      nero55      3,1

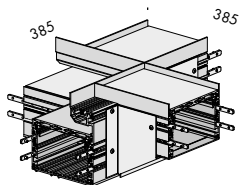

**f6.223.31** raccordo + con coperchio ribassato  
+ coupler with low lid      nero55      3,8

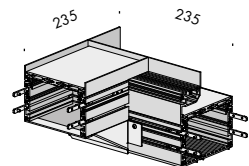

**f6.223.24** raccordo dx L con coperchio ribassato  
right L coupler with low lid      nero55      3,1

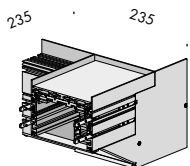

**f6.223.25** raccordo sx L con coperchio ribassato  
left L coupler with low lid      nero55      3,1

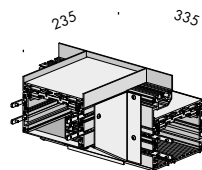

**f6.223.26** raccordo T con coperchio ribassato  
T coupler with low lid      nero55      3,8

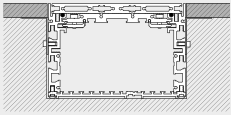

**cc** f6.223.02  
aituoipiedi centrale 96

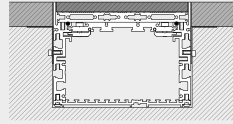

**cm** f6.223.01  
aituoipiedi centrale 106

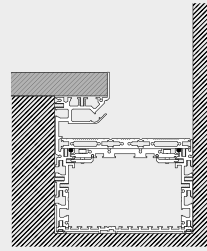

**p** f6.223.03  
aituoipiedi perimetrale 162

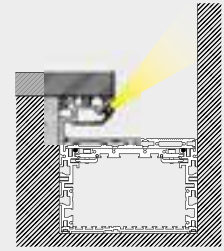

**pl** f6.223.03 + 13x8  
aituoipiedi perimetrale 162

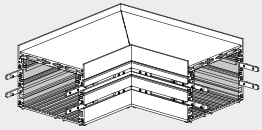

**1** f6.223.21

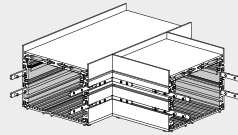

**2** f6.223.22

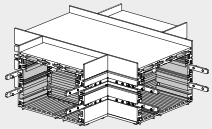

**3** f6.223.23

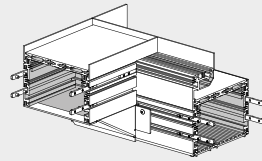

**4** f6.223.24

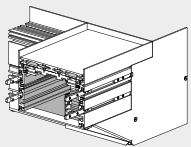

**5** f6.223.25

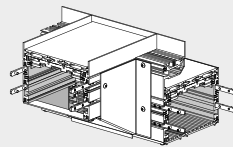

**6** f6.223.26

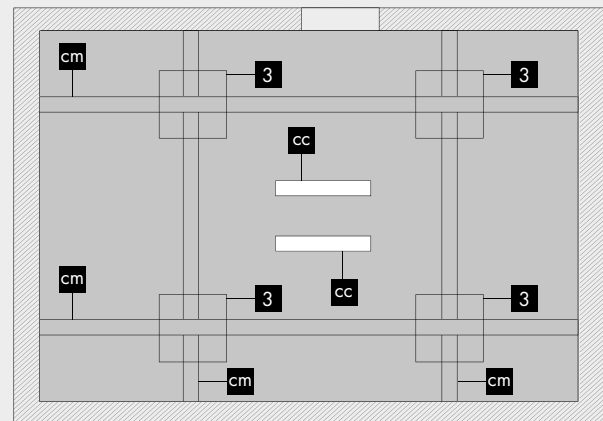
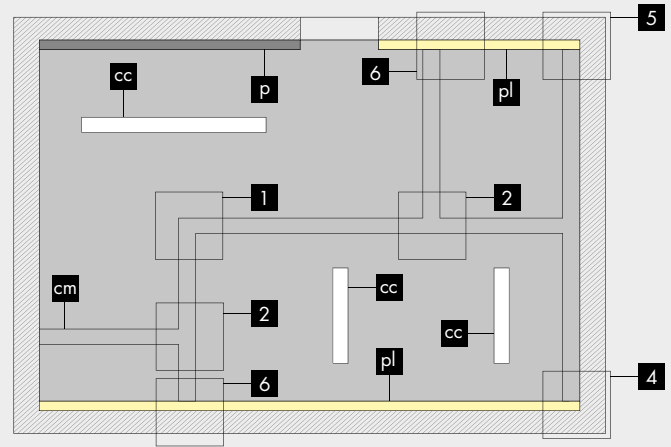



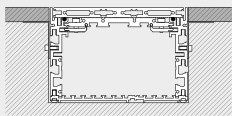

**cc** f6.223.02  
aituoipiedi centrale 96

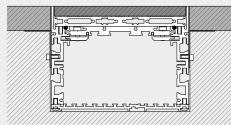

**cm** f6.223.01  
aituoipiedi centrale 106

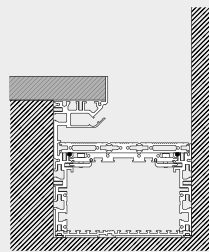

**p** f6.223.03  
aituoipiedi perimetrale 162

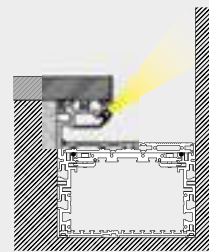

**pl** f6.223.03 + 13x8  
aituoipiedi perimetrale 162

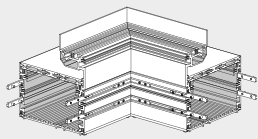

**7** f6.223.27

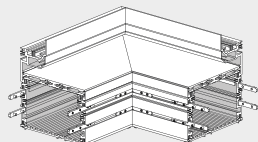

**8** f6.223.28

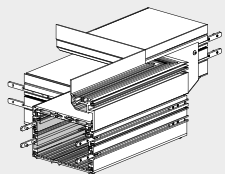

**9** f6.223.29

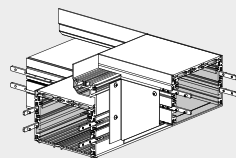

**10** f6.223.39

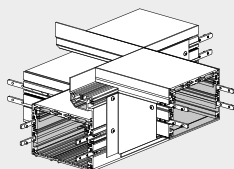

**11** f6.223.40

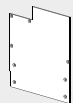

**12** f6.223.19

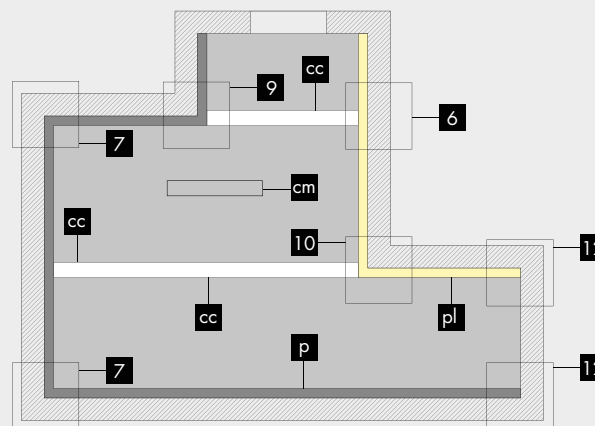
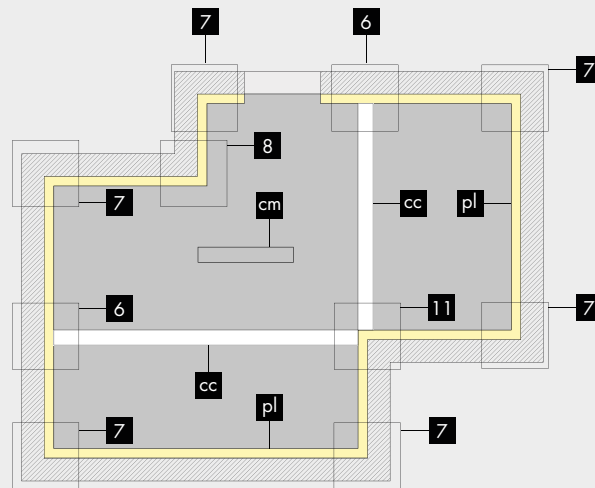





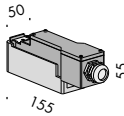
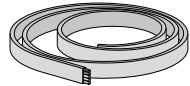
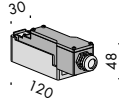
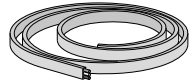

accessori. accessories.		IP67	★	CE	ⓘ
<b>f9.223.61</b>	cavo di alimentazione power supply cable	3x2,5 mm <sup>2</sup>	250V 20A	25m	6,3
<b>f9.223.62</b>	cavo di alimentazione power supply cable	3x2,5 mm <sup>2</sup>	250V 20A	100m	25,2
<b>f9.223.65</b>	derivazione alimentazione 3 poli a perforazione d'isolante 3 poles supply electric derivation insulation displacement				0,1
<b>f9.223.66</b>	terminale di protezione per cavo 3 poli end cap protection for 3 poles cable				0,2
<b>f9.223.71</b>	cavo di alimentazione power supply cable	5x2,5 mm <sup>2</sup>	250V 20A	25m	6,3
<b>f9.223.72</b>	cavo di alimentazione power supply cable	5x2,5 mm <sup>2</sup>	250V 20A	100m	25,2
<b>f9.223.75</b>	derivazione alimentazione 5 poli a perforazione d'isolante 5 poles supply electric derivation insulation displacement				0,1
<b>f9.223.76</b>	terminale di protezione per cavo 5 poli end cap protection for 5 poles cable				0,2

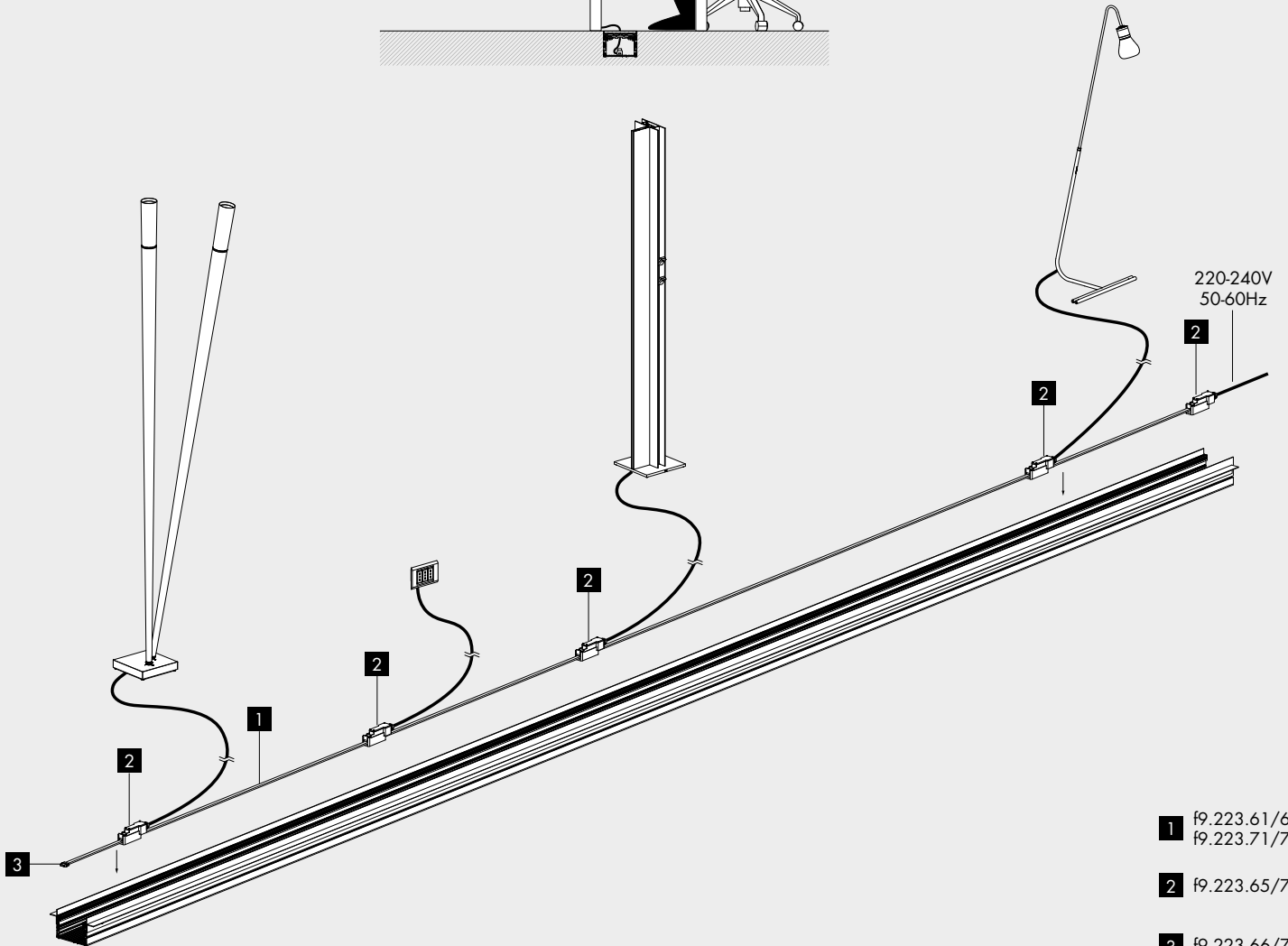
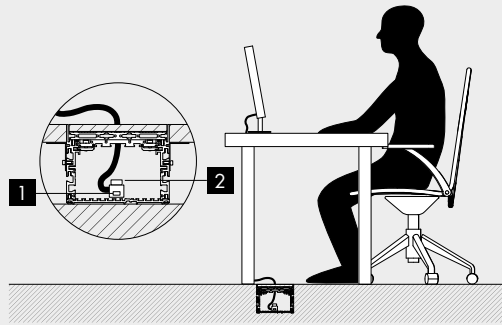

1 f9.223.61/62  
f9.223.71/72

2 f9.223.65/75

3 f9.223.66/76

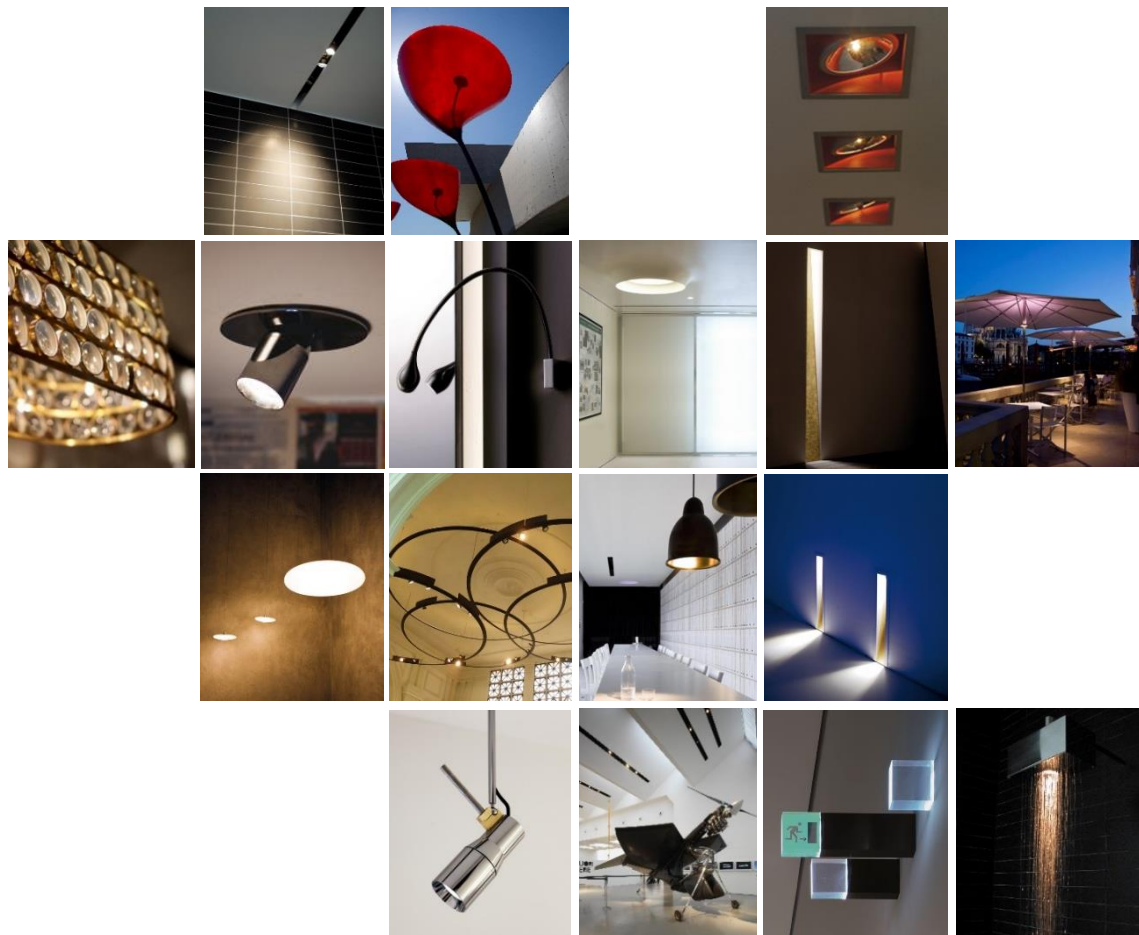

Subscribe To Our Newsletter



**Distributor for Viabizzuno  
Architectural Lighting Solutions**

Web: [www.cirruslighting.co.uk](http://www.cirruslighting.co.uk)

Email: [sales@cirruslighting.co.uk](mailto:sales@cirruslighting.co.uk)

Tel: 0207 193 2175

Fax: 0207 193 3175

