

scala · scale 1:1

**apparecchio di illuminazione a parete o soffitto per interni IP20.
realizzato in estruso di alluminio ossidato 13x8mm di sezione ad H, con lunghezze fino a
2110mm con un passo di 100mm.
un lato del profilo si fissa ad un secondo estruso che funge da staffa di fissaggio
agevolandone l'installazione.
diffusore in policarbonato satinato della stessa lunghezza del profilo.
cablato con sorgente elettronica lineare con limitatore di corrente integrato, 3000K Ra95
13W/m fino a 27,3W 2620lm. predisposto all'estremità con connettori amp2 maschio e
femmina.
alimentatore in tensione costante 24vdc escluso, da installare remoto.
accessori: tappi di chiusura.
finiture: argento opaco.**

**IP20 rated wall or ceiling light fitting for indoor use.
made of 13x8mm oxidised aluminium extrusion, with H section, length up to 2110mm with
a 100mm pitch.
a side of the profile can be fixed to a second extrusion that serves as a fixing bracket for an
easier installation.
frosted polycarbonate diffuser having the same length of the profile.
wired with a 3000K Ra95 13W/m up to 27.3W 2620lm linear led source with integrated
current limiter, fitted with amp2 female or male connectors at the end.
24Vdc constant voltage power supply not included, to be installed remotely.
accessories: closing cups.
finish: matt silver.**





13x8 e entra		24Vdc		IP20	CE	
Vb6.204.31	argento opaco · matt silver	3000K	1,3W	110mm	0,04	
Vb6.204.32	argento opaco · matt silver	3000K	2,6W	210mm	0,07	
Vb6.204.33	argento opaco · matt silver	3000K	3,9W	310mm	0,1	
Vb6.204.34	argento opaco · matt silver	3000K	5,2W	410mm	0,1	
Vb6.204.35	argento opaco · matt silver	3000K	6,5W	510mm	0,2	
Vb6.204.36	argento opaco · matt silver	3000K	7,8W	610mm	0,2	
Vb6.204.37	argento opaco · matt silver	3000K	9,1W	710mm	0,2	
Vb6.204.38	argento opaco · matt silver	3000K	10,4W	810mm	0,3	
Vb6.204.39	argento opaco · matt silver	3000K	11,7W	910mm	0,3	
Vb6.204.40	argento opaco · matt silver	3000K	13W	1010mm	0,3	
Vb6.204.41	argento opaco · matt silver	3000K	14,3W	1110mm	0,4	
Vb6.204.42	argento opaco · matt silver	3000K	15,6W	1210mm	0,4	
Vb6.204.43	argento opaco · matt silver	3000K	16,9W	1310mm	0,4	
Vb6.204.44	argento opaco · matt silver	3000K	18,2W	1410mm	0,5	
Vb6.204.45	argento opaco · matt silver	3000K	19,5W	1510mm	0,5	
Vb6.204.46	argento opaco · matt silver	3000K	20,8W	1610mm	0,5	
Vb6.204.47	argento opaco · matt silver	3000K	22,1W	1710mm	0,5	
Vb6.204.48	argento opaco · matt silver	3000K	23,4W	1810mm	0,6	
Vb6.204.49	argento opaco · matt silver	3000K	24,7W	1910mm	0,6	
Vb6.204.50	argento opaco · matt silver	3000K	26W	2010mm	0,7	
Vb6.204.51	argento opaco · matt silver	3000K	27,3W	2110mm	0,7	

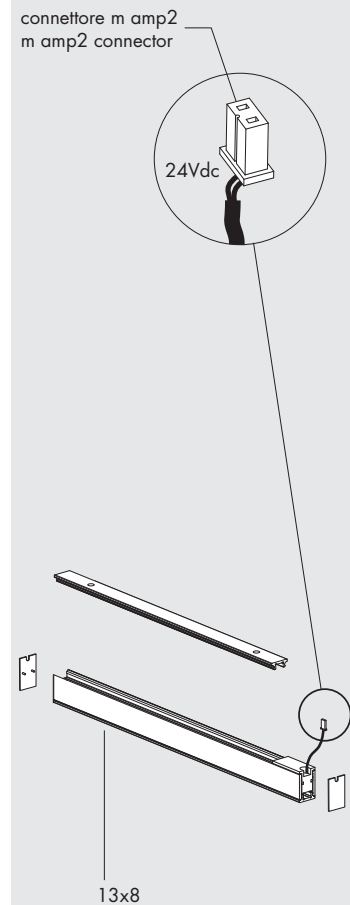

Ra	R9	ies tm/30		sdcm	Vf	lm/m	W/m	lm/W	
95	90	Rf 93	Rg 102	step 2	24	1250	13	96	A+
V0001	5,9	Ta25 °C		vita media · average life	50000 h	L80	B10		

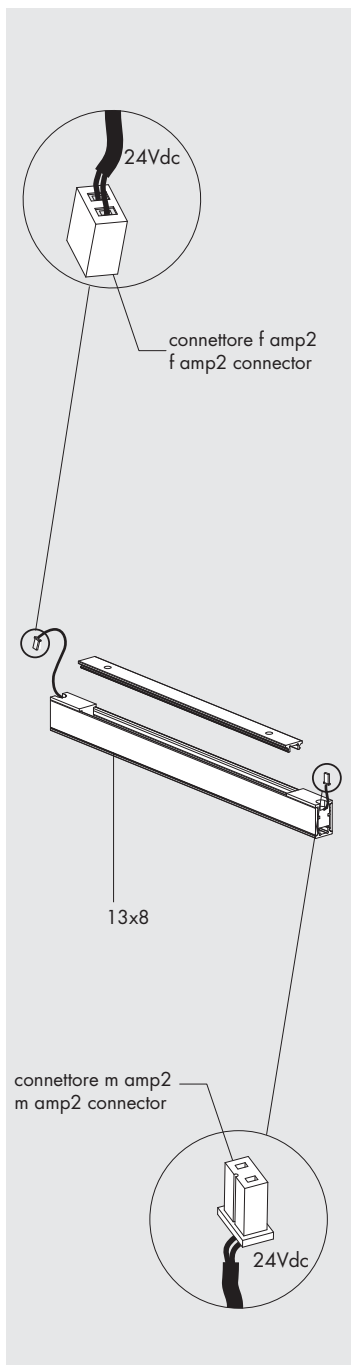

13x8 e-e entra-esca		24Vdc					CE	
Vb6.204.01	argento opaco · matt silver	3000K	1,3W	110mm	0,04			
Vb6.204.02	argento opaco · matt silver	3000K	2,6W	210mm	0,07			
Vb6.204.03	argento opaco · matt silver	3000K	3,9W	310mm	0,1			
Vb6.204.04	argento opaco · matt silver	3000K	5,2W	410mm	0,1			
Vb6.204.05	argento opaco · matt silver	3000K	6,5W	510mm	0,2			
Vb6.204.06	argento opaco · matt silver	3000K	7,8W	610mm	0,2			
Vb6.204.07	argento opaco · matt silver	3000K	9,1W	710mm	0,2			
Vb6.204.08	argento opaco · matt silver	3000K	10,4W	810mm	0,3			
Vb6.204.09	argento opaco · matt silver	3000K	11,7W	910mm	0,3			
Vb6.204.10	argento opaco · matt silver	3000K	13W	1010mm	0,3			
Vb6.204.11	argento opaco · matt silver	3000K	14,3W	1110mm	0,4			
Vb6.204.12	argento opaco · matt silver	3000K	15,6W	1210mm	0,4			
Vb6.204.13	argento opaco · matt silver	3000K	16,9W	1310mm	0,4			
Vb6.204.14	argento opaco · matt silver	3000K	18,2W	1410mm	0,5			
Vb6.204.15	argento opaco · matt silver	3000K	19,5W	1510mm	0,5			
Vb6.204.16	argento opaco · matt silver	3000K	20,8W	1610mm	0,5			
Vb6.204.17	argento opaco · matt silver	3000K	22,1W	1710mm	0,6			
Vb6.204.18	argento opaco · matt silver	3000K	23,4W	1810mm	0,6			
Vb6.204.19	argento opaco · matt silver	3000K	24,7W	1910mm	0,6			
Vb6.204.20	argento opaco · matt silver	3000K	26W	2010mm	0,7			
Vb6.204.21	argento opaco · matt silver	3000K	27,3W	2110mm	0,7			

Ra	R9	ies tm/30		sdc	Vf	lm/m	W/m	lm/W	
95	90	Rf 93	Rg 102	step 2	24	1250	13	96	A+
V0001	5,9	Ta25 °C		vita media · average life	50000 h	L80	B10		

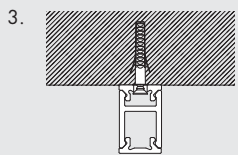
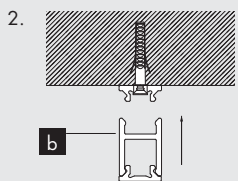
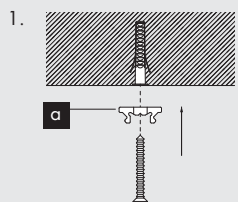
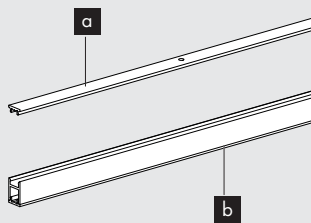

a coperchio in alluminio
aluminium cover

b 13x8



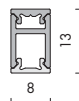

13x8



f6.204.91	profilo vuoto + policarbonato empty profile + polycarbonate	4 pz · pcs	3000mm	2
f6.204.90	profilo vuoto + policarbonato empty profile + polycarbonate	100 pz · pcs	3000mm	50

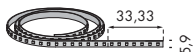

linea di luce Ra95/13

24Vdc



Vb6.250.121 2700K 6000mm 0,6

Ra	R9	ies tm/30		sdc	Vf	lm/m	W/m	lm/W	
95	90	Rf 90	Rg 98	step 2	24	1200	13	92	A+
V0000	5,9	Ta25 °C		vita media · average life		50000 h	L80 B10		

Vb6.250.122 3000K 6000mm 0,6

Ra	R9	ies tm/30		sdc	Vf	lm/m	W/m	lm/W	
95	90	Rf 93	Rg 102	step 2	24	1250	13	96	A+
V0001	5,9	Ta25 °C		vita media · average life		50000 h	L80 B10		

Vb6.250.123 4000K 6000mm 0,6

Ra	R9	ies tm/30		sdc	Vf	lm/m	W/m	lm/W	
95	95	Rf 90	Rg 98	step 2	24	1300	13	100	A+
V0003	5,9	Ta25 °C		vita media · average life		50000 h	L80 B10		

Vb6.250.124 5000K 5000K 6000mm 0,6

Ra	R9	ies tm/30		sdc	Vf	lm/m	W/m	lm/W	
95	95	Rf 90	Rg 98	step 2	24	1300	13	100	A+
V0005	5,9	Ta25 °C		vita media · average life		50000 h	L80 B10		

cavi con connettore femmina amp2. cables with amp2 female connector. IP20 ☆ CE i

f9.204.90

150mm 0,01

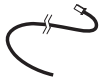

cavi con connettori m/f amp2. cables with m/f amp2 connectors. IP20 ☆ CE i

f9.204.91

2000mm 0,3

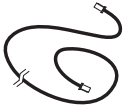

accessori. accessories.

☆ CE i

f9.204.80 tappi di chiusura · closing caps

100 pz · pcs 0,1

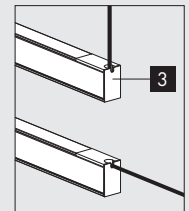
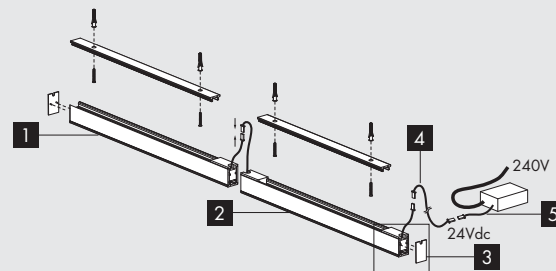
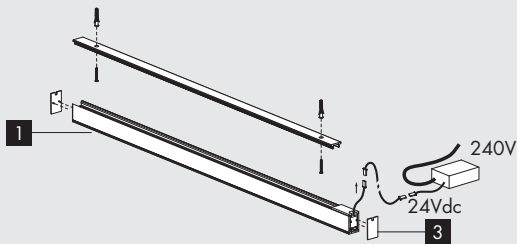
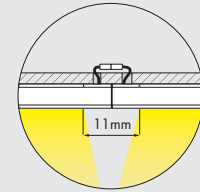
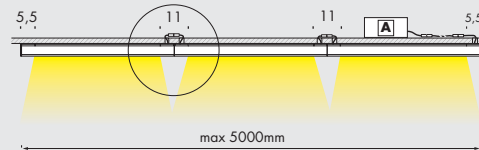
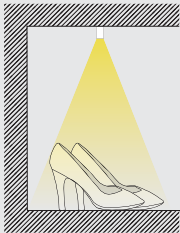
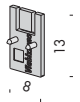

- 1** 13x8
n.1 connettore maschio amp2 · male connector
- 2** 13x8
n.2 connettori m/f amp2 · connectors
- 3** tappo di chiusura incluso
end cap included

- 4** f9.204.91 l.2000mm cavo · cable
n.2 connettori m/f amp2 · connectors
- 5** f9.204.90 l.150mm cavo · cable
n.1 connettore femmina amp2 · connector

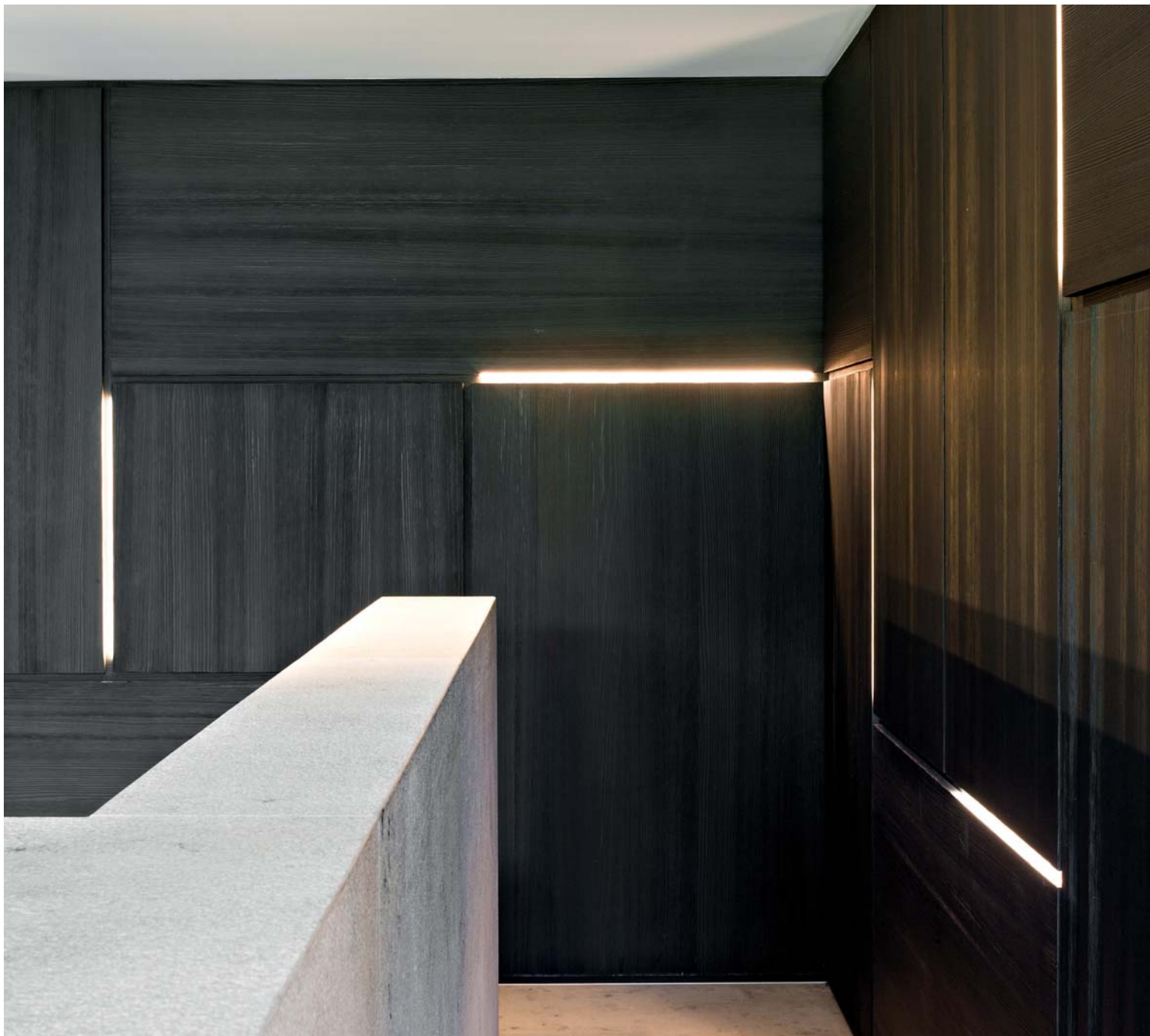



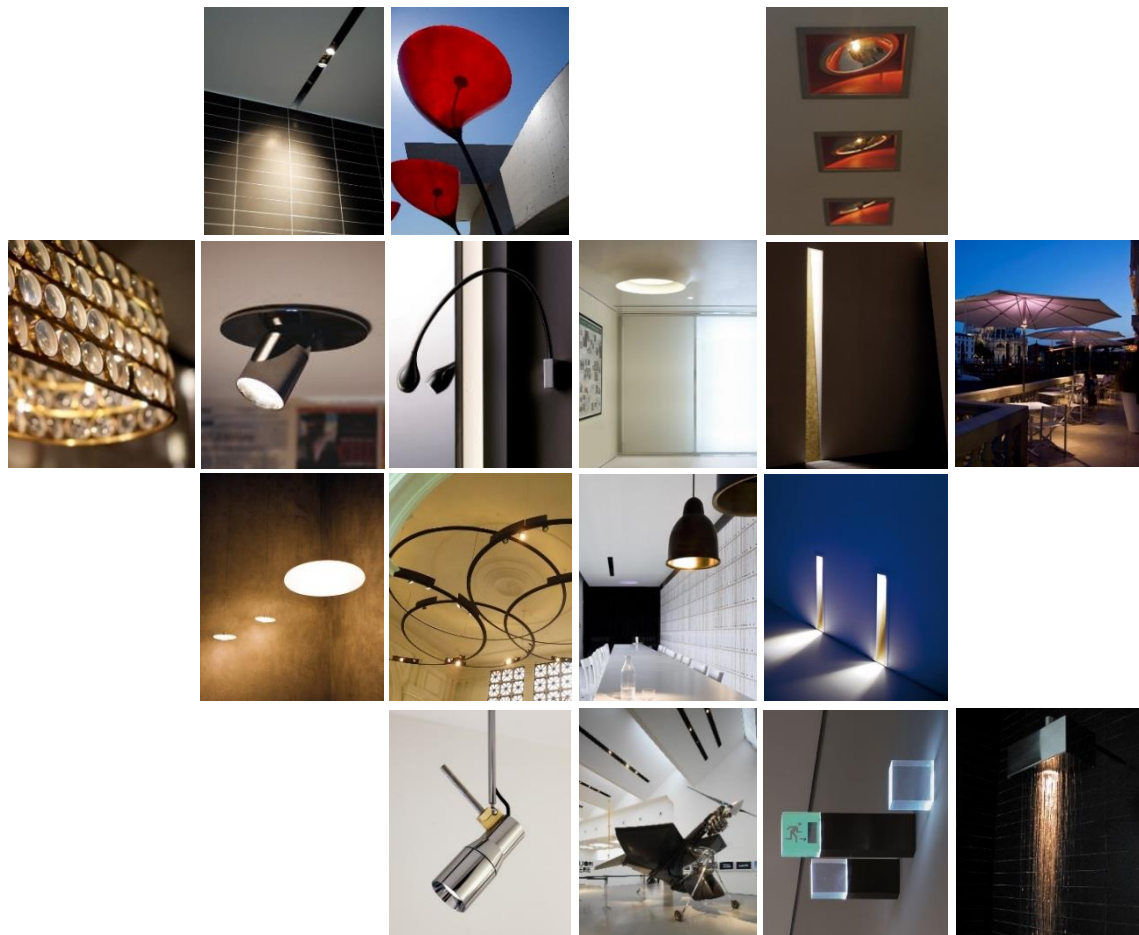

Subscribe To Our Newsletter



**Distributor for Viabizzuno
Architectural Lighting Solutions**

Web: www.cirruslighting.co.uk

Email: sales@cirruslighting.co.uk

Tel: 0207 193 2175

Fax: 0207 193 3175

